

# User Manual

POS System series  
YUNO151 / YUNO151K  
and  
YUNO156 / YUNO156-50KH



## Copyrights

©2015 All rights reserved. The information in this document is subject to change without prior notice in order to improve reliability, design and function and does not represent a commitment on the part of the manufacturer.

This document contains proprietary information protected by copyright. All rights are reserved. No part of this manual may be reproduced by any mechanical, electronic, or other means in any form without prior written permission of the manufacturer.

All trademarks are property of their respective owners

## Liability Disclaimer

In no event will the manufacturer be liable for direct, indirect, special, incidental, or consequential damages arising out of the use or inability to use the product or documentation, even if advised of the possibility of such damages.

## Regulatory Information

### FCC Notice



This equipment has been tested and found to comply with the limits for a Class A digital device, pursuant to Part 15 of the Federal Communications Commission (FCC) Rules. These limits are designed to provide reasonable protection against harmful interference in a residential installation. This equipment generates, uses, and can radiate radio frequency energy and, if not installed and used in accordance with the instructions, may cause harmful interference to radio communications. However, there is no guarantee that interference will not occur in a particular installation. If

this equipment does cause harmful interference to radio or television reception, which can be determined by turning the equipment off and on, the user is encouraged to try to correct the interference by one or more of the following measures:

- Increase the separation between the equipment and the receiver.
- Connect the equipment into an outlet on a circuit different from that to which the receiver is connected.
- Consult the dealer or an experienced radio or television technician for help.

**NOTE: THE MANUFACTURER IS NOT RESPONSIBLE FOR ANY RADIO OR TV INTERFERENCE CAUSED BY UNAUTHORIZED MODIFICATIONS TO THIS DEVICE. SUCH MODIFICATIONS COULD VOID THE USER'S AUTHORITY TO OPERATE THE DEVICE.**

### CE Notice



This device complies with **EMC Directive 2004/108/EC** and **2006/95/EC "Low Voltage Directive"** issued by the Commission of the European Community.

### UL Notice



This manual refers to UL certified products and conforms to UL 60950-1 & CAN/CSA C22.2 No. 60950-1-07 STANDARD FOR Information Technology Equipment - Safety - Part 1: General Requirements.

## WEEE Notice



The **WEEE** mark applies only to countries within the European Union (EU) and Norway.

This appliance is labeled in accordance with **European Directive 2002/96/EC** concerning **waste electrical and electronic equipment (WEEE)**. The Directive determines the framework for the return and recycling of used appliances as applicable throughout the European Union. This label is applied to various products to indicate that the product is not to be thrown away, but rather reclaimed upon end of life per this Directive.

### **CAUTION :**

**Risk of Explosion if Battery is replaced by an incorrect Type.**

**Dispose of Used Batteries According to the instructions.**

## Safety

### **IMPORTANT SAFETY INSTRUCTIONS**

To disconnect the machine from the electrical Power Supply, turn off the power switch and remove the power cable plug from the wall socket. The wall socket must be easily accessible and in close proximity to the machine.

Read these instructions carefully. Save these instructions for future reference.

Follow all warnings and instructions marked on the product.

Do not use this product near water.

Do not place this product on an unstable cart, stand, or table. The product may fall, causing serious damage to the product.

Slots and openings in the cabinet and the back or bottom are provided for ventilation; to ensure reliable operation of the product and to protect it from overheating. These openings must not be blocked or covered. The openings should never be blocked by placing the product on a bed, sofa, rug, or other similar surface. This product should never be placed near or over a radiator or heat register, or in a built-in installation unless proper ventilation is provided.

This product should be operated from the type of power indicated on the marking label. If you are not sure of the type of power available, consult your dealer or local power company.

Do not allow anything to rest on the power cord. Do not locate this product where persons will walk on the cord. Never push objects of any kind into this product through cabinet slots as they may touch dangerous voltage points or short out parts that could result in a fire or electric shock. Never spill liquid of any kind on the product.







# Table of Contents

<b>Copyrights</b> .....	<b>i</b>
<b>Liability Disclaimer</b> .....	<b>i</b>
<b>Regulatory Information</b> .....	<b>i</b>
FCC Notice .....	i
CE Notice.....	i
UL Notice .....	i
WEEE Notice .....	ii
Safety .....	ii
<b>Table of Contents</b> .....	<b>iii</b>
<b>1. Item Checklist</b> .....	<b>1</b>
1.1 Standard Items .....	1
1.2 Optional Items .....	2
<b>2. System View</b> .....	<b>3</b>
2.1 Front View.....	3
2.2 Rear View .....	4
2.3 Side View .....	5
2.4 Dimension .....	6
2.5 I/O View .....	9
<b>3. POS System Assembly &amp; Disassembly</b> .....	<b>10</b>
3.1 Open the System Cover .....	10
3.2 Replace the Storage Disk Drive .....	11
3.3 Replace the Memory .....	14
3.4 Install the Power Adapter .....	16
3.5 Install the Wall-mount.....	18
<b>4. Peripherals Installation</b> .....	<b>21</b>
4.1 Install the Cash Drawer .....	21
4.2 Install the Attachment-type Customer Display (YUNO-VFD) and Second Display (YUNO-2NDLCD10.1) .....	23
4.3 Install other Attachment-type Peripherals .....	24
4.4 Install the Wi-Fi Bluetooth Module (YUNO-KIT-WIFI) .....	25
<b>5. Specification</b> .....	<b>29</b>
<b>6. Configuration</b> .....	<b>32</b>
6.1 X72 Motherboard.....	32
6.1.1 Motherboard Layout.....	32
6.1.2 Connectors & Functions .....	33
6.1.3 Jumper Settings.....	34
6.2 X7D Motherboard .....	35

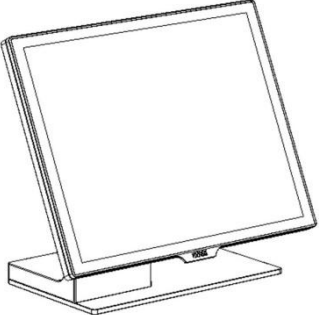
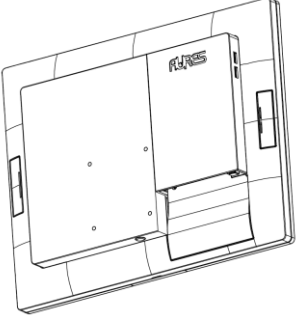
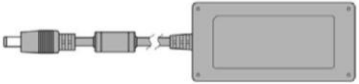
6.2.1 Motherboard Layout.....	35
6.2.2 Connectors & Functions .....	36
6.2.3 Jumper Settings.....	37
<b>Appendix A: Driver Installation .....</b>	<b>38</b>
1. Installation Note of USB 3.0 Driver with Bay Trail YUNO.....	39
2. Application Note of installing POSReady 7 or Windows 7 with Broadwell YUNO...	45
<b>Appendix B: Customer Display Command Settings (F/W : v1.06).....</b>	<b>47</b>

# 1. Item Checklist

## 1.1 Standard Items

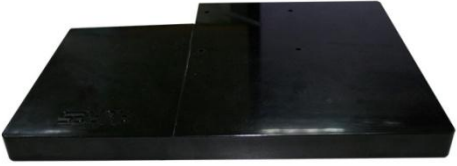
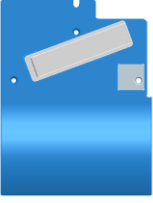
	
<p>a. System : YUNO151 &amp; YUNO-156 / 156-50KH      YUNO151K</p>	
	
<p>b. Power Adapter (65W)</p>	<p>c. Power Cable</p>
	
<p>d. RJ50-COM Cable 100cm (x3), plus, RJ50-COM Cable 50cm (x1)</p>	<p>e. Manual CD</p>
	
<p>f. Safety Instructions Sheet</p>	<p>g. Website Address Sheet</p>
	
<p>h. Peripheral Adapter</p>	<p>i. System Cover for YUNO151K</p>
	
<p>j. VESA Cover for YUNO151K</p>	

## 1.2 Optional Items

YUNO supports full range of peripherals as listed below.

Model #	Description
YUNO-VFD	RS-232 interface Attachment-type (integrated) Customer Display
YUNO-2NDLCD10.1	USB interface Attachment-type (integrated) Second Display (non-Touch and Touch models)
YUNO-MSRLONG	3-Track USB Keyboard HID Attachment-type (integrated) Magnetic Stripe Reader
YUNO-SCANNER2D	USB interface Attachment-type (integrated) 2D Scanner
YUNO-DALLAS	USB Keyboard and USB/COM interface Attachment-type (integrated) Dallas Key Reader
YUNO-ADDIMAT	USB Keyboard and USB/COM interface Attachment-type (integrated) Addimat Key Reader
YUNO-KIT-WIFI	Wi-Fi Bluetooth Module 2.4/5GHz, 802.11ac, a/b/g, n
YUNO-ALIM-11/36V	DC/DC Switching Power Adapter Input Voltage : 36Vdc Output Voltage : 19Vdc
YUNO-UPS	19V DC Uninterruptible Power Supply Kit

## 2. System View

### 2.1 Front View

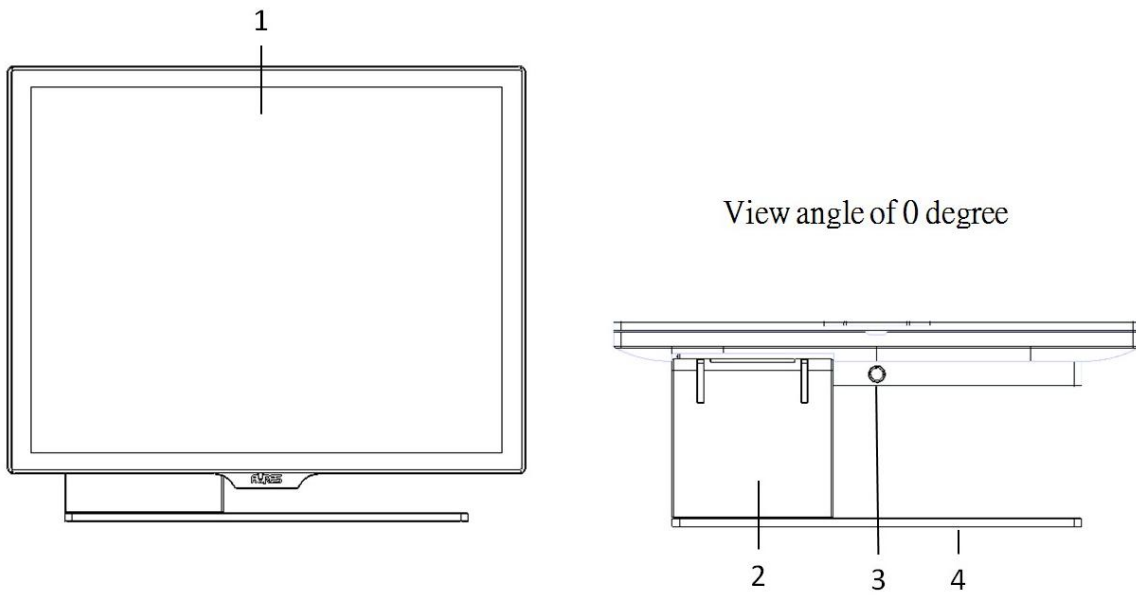

Number	Description
1	Bezel Free Panel PC
2	L-Stand
3	System Cover Release Button
4	Base Plate



## 2.2 Rear View

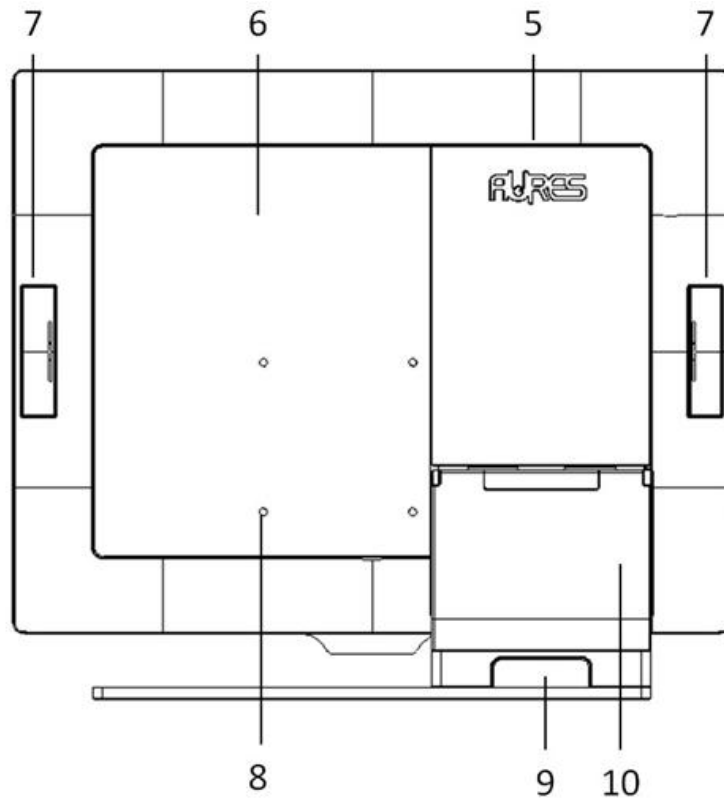

Number	Description
5	Attachment-type Customer Display (YUNO-VFD) service door
6	System Cover
7	service door for peripherals
8	VESA mount (75mm x 75mm)
9	Rear Side Cable service door
10	L-Stand Cover

Rear View of YUNO151K for reference :

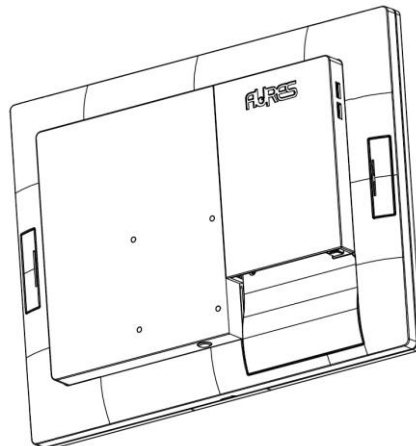

## 2.3 Side View

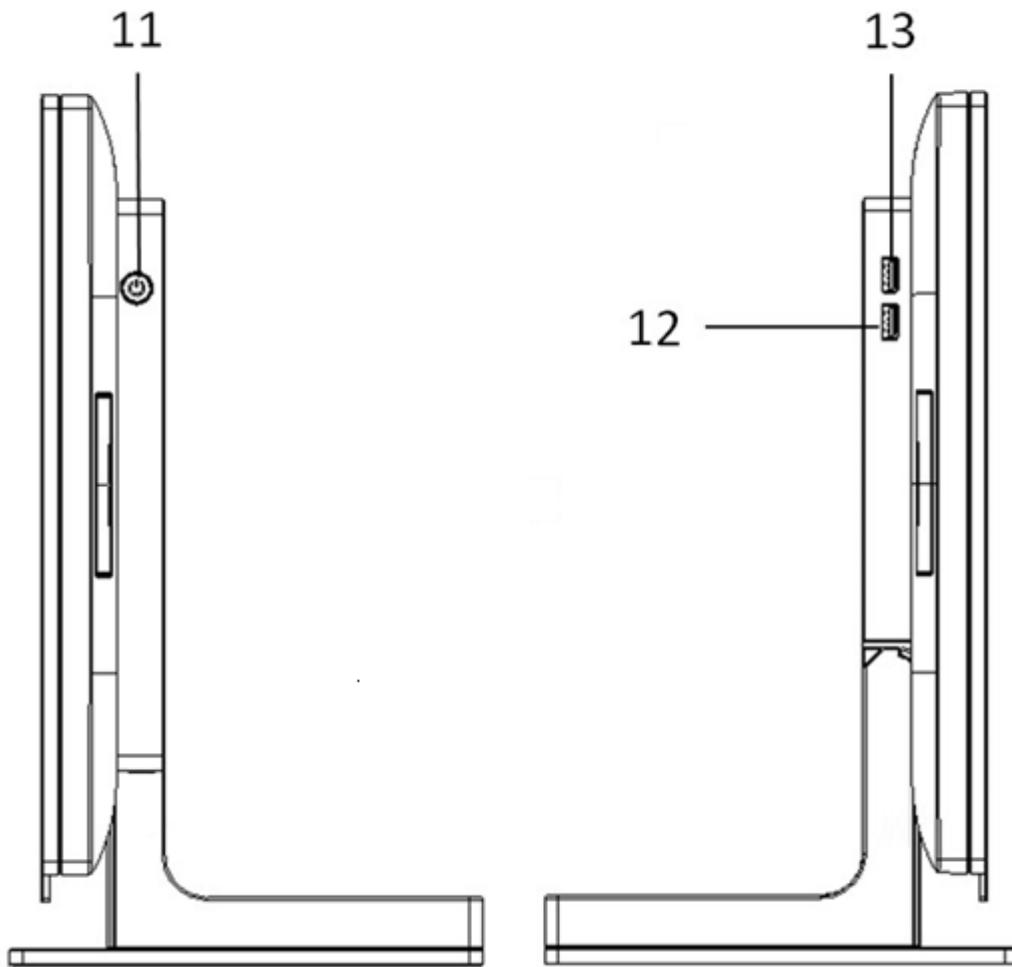

Number	Description
11	Power Button
12	X72 motherboard : 1 x USB 2.0 (Type A) X7D motherboard : 1 x USB 3.0 (Type A)
13	X72 and X7D motherboard : 1 x USB 3.0 (Type A)

## 2.4 Dimension

For YUNO151,

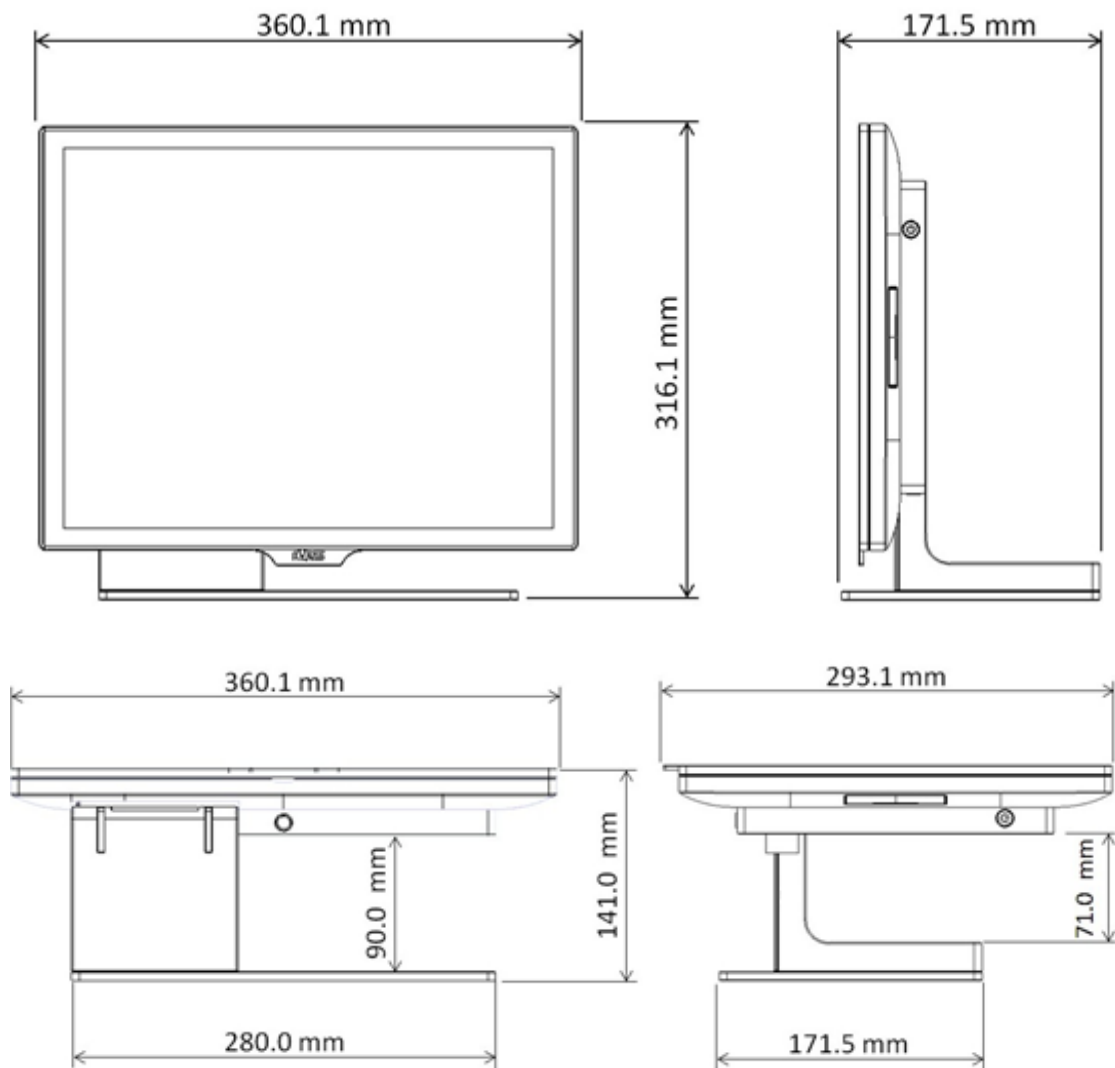

For YUNO156 / YUNO156-50KH,

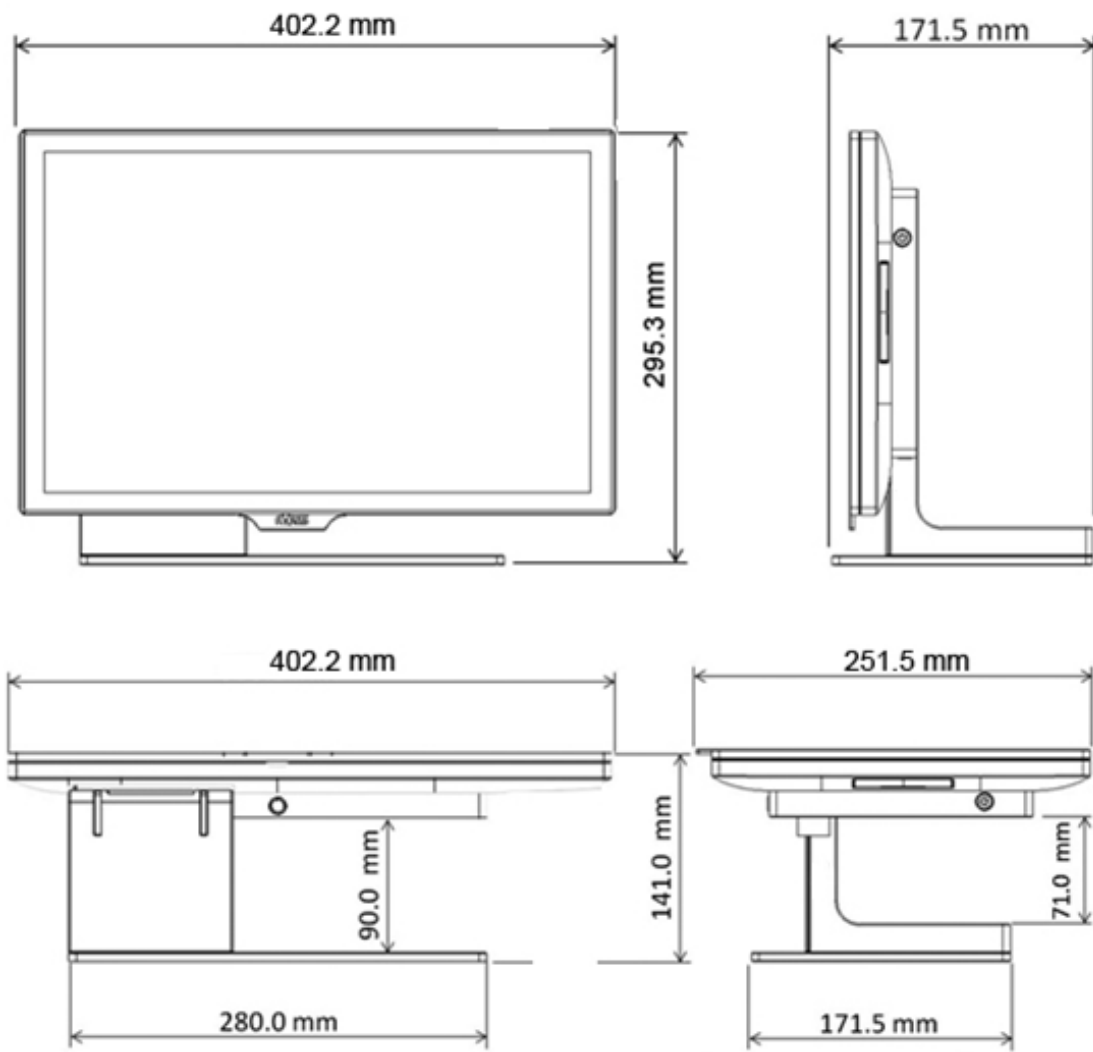

For YUNO151K,

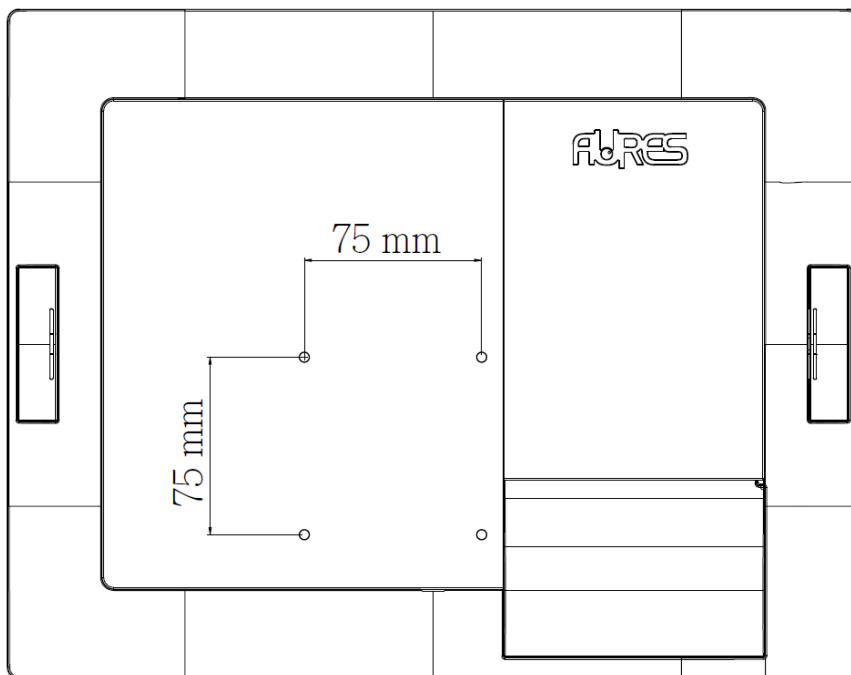
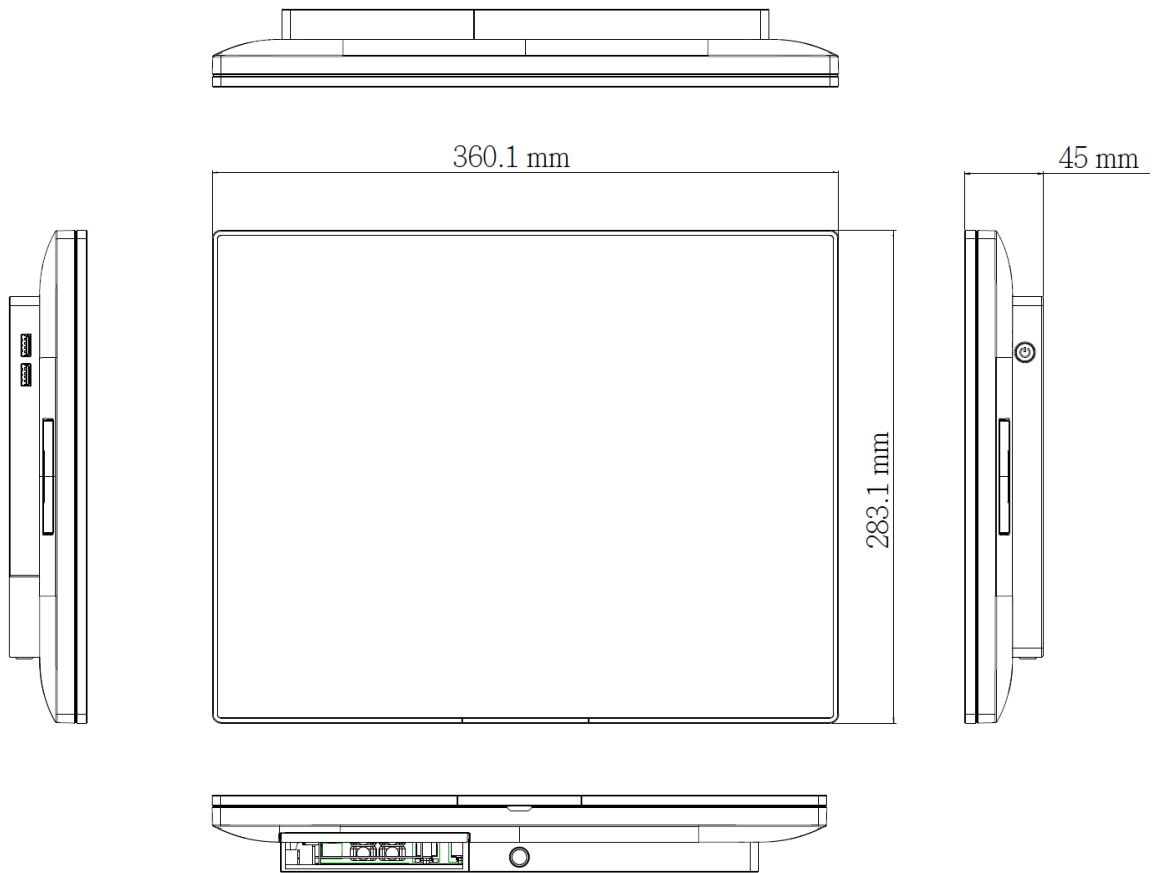

## 2.5 I/O View

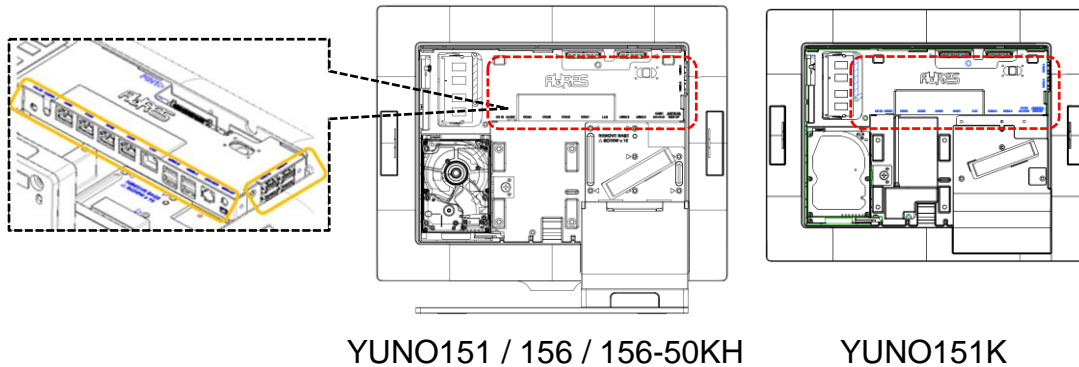

Bottom-up View

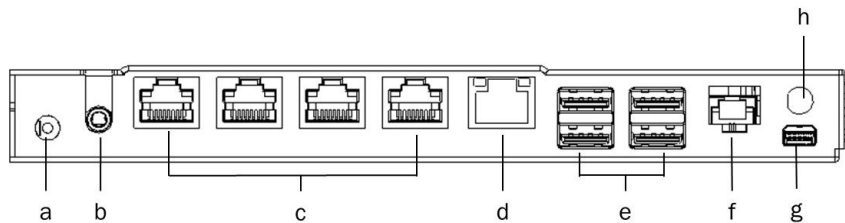

Right-side View

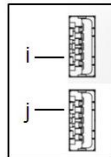

Bottom-up View	
Number	Description
a	DC-IN jack
b	Combo Audio jack (3.5mm 4 conductor)
c	COM1~4 (from right to left) (RJ50 Connector)
d	LAN (RJ45 Connector)
e	4 x USB 2.0 (Type A)
f	Cash Drawer (RJ12 Connector)
g	mini DP (Display Port)
h	reserved for Wi-Fi /Bluetooth

Right-side View	
Number	Description
i	1 x USB 3.0 (Type A)
j	X72 motherboard : 1 x USB 2.0 (Type A) X7D motherboard : 1 x USB 3.0 (Type A)

### 3. POS System Assembly & Disassembly

Since YUNO151K is an alternative Panel PC SKU out from standard YUNO151, its difference is without the L-Base part. Diagrams of YUNO151 are used as a representative of all YUNO POS System series for elaboration in the rest of this manual.

#### 3.1 Open the System Cover

Open the System Cover by pressing the System Cover Release Button.

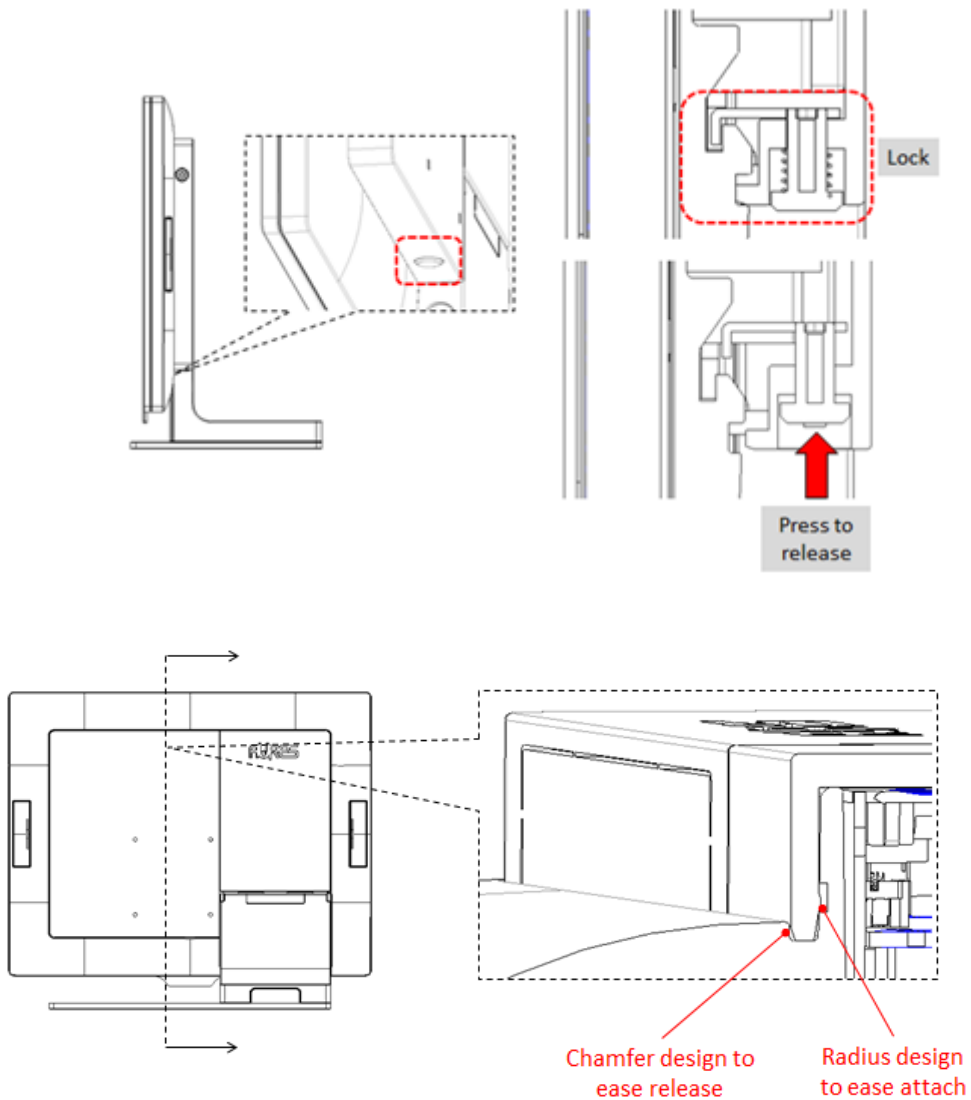

## 3.2 Replace the Storage Disk Drive

YUNO POS System series offers two 2.5" drive bays of height 7 mm each to allow you to equip it with a configuration of one primary HDD or SSD on the upper bay and one secondary SSD on the lower bay.

\*Please note that if you are replacing your only HDD or SSD, you will need to reinstall your operating system after replacing it.

Make sure the unit is powered off before starting.

Please follow the below steps to finish the replacement :

### 1. Remove the System Cover

To open the System Cover, please refer to the procedures described in Chapter 3-1 and remove it.

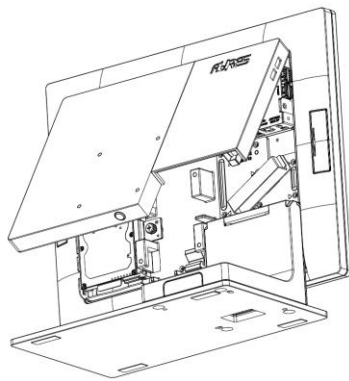

YUNO151 / 156 / 156-50KH

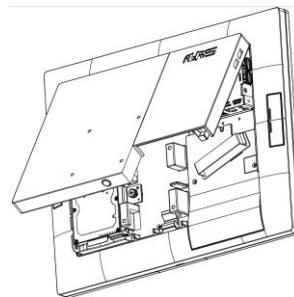

YUNO151K

### 2. Remove the old drive (if applicable).

If you are removing a HDD or SSD, make sure all of the cables are disconnected from both the motherboard and the power supply. Rotate the Releasing Handler to unlock the storage disk drive and slide it out of the housing.

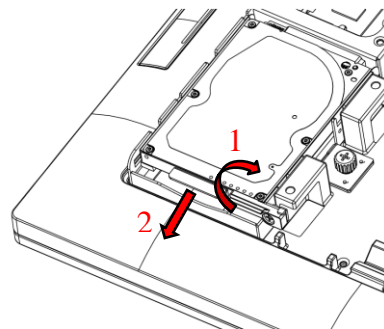



3. Insert your new drive.

Remove it from the antistatic packaging and slide it into your target drive bay of the storage housing.

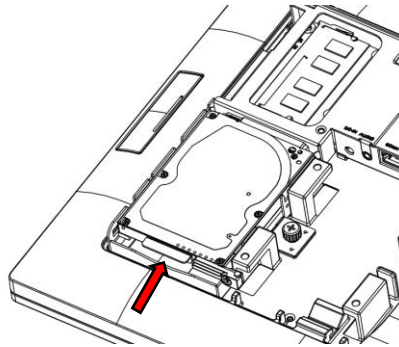

4. Secure the storage disk drive.

Once the storage disk drive has been completely inserted, rotate the Releasing Handler to lock it properly.

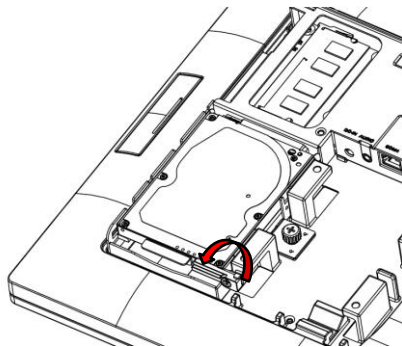

5. Connect the storage disk drive to the motherboard.

\*If you are connecting your primary storage disk drive, the SATA cable should be plugged into the first SATA channel, which is labeled as SATA0. Refer to Chapter 6 about the motherboard configuration for detailed information.

Secondary drive should be connected to the next available SATA1 channel.

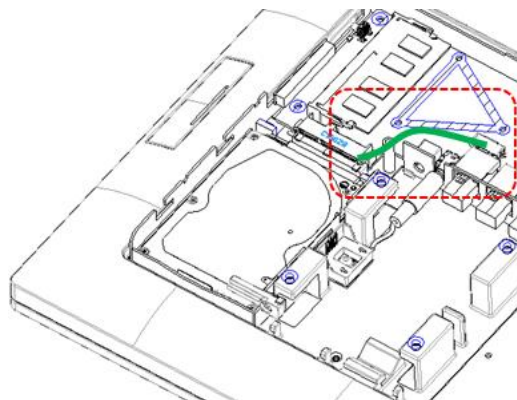

6. Connect the power supply to the storage disk drive.  
HDD1 labeled on the motherboard provides power supply to the primary storage disk drive, while HDD2 is for the secondary storage disk drive.  
Make sure that all of your connections are secure.
7. Get ready to power on the system.

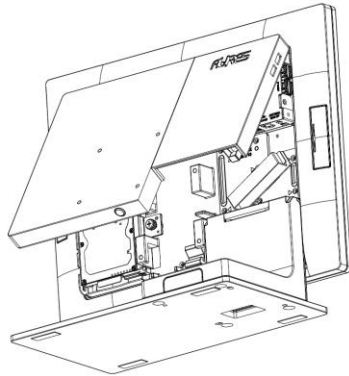

YUNO151 / 156 / 156-50KH

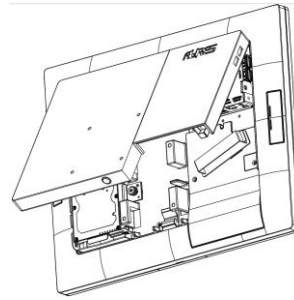

YUNO151K

Close up the System Cover.  
Reconnect the cable plug onto the wall socket and turn your YUNO on.

8. Finish the replacement.  
If you are replacing your primary drive, you'll have to reinstall your operating system.  
If you are adding a new drive, you'll need to format the drive before you can use it.

### 3.3 Replace the Memory

Make sure the system is powered off before starting.

Please follow the below steps to finish the replacement :

1. Remove the System Cover

To open the System Cover, please refer to the procedures described in Chapter 3-1 and remove it.

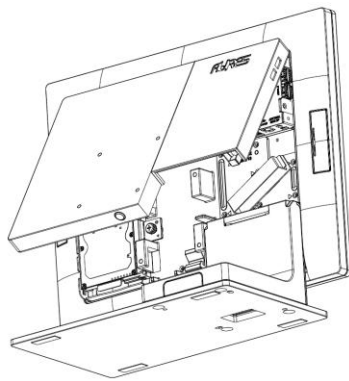

YUNO151 / 156 / 156-50KH

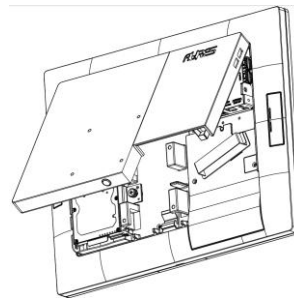

YUNO151K

2. Locate the memory slot at the left rear side of the system.

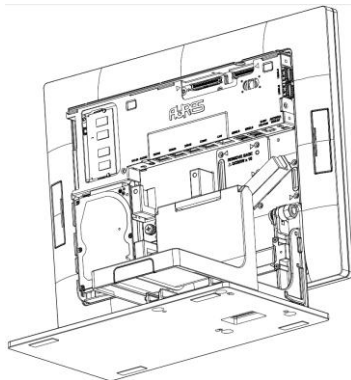

YUNO151 / 156 / 156-50KH

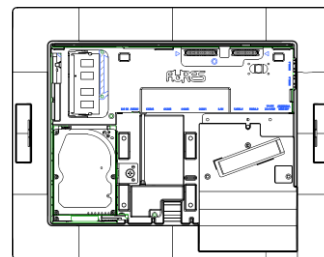

YUNO151K

3. Flip the ejector clips outwards to remove the memory module from the memory slot.

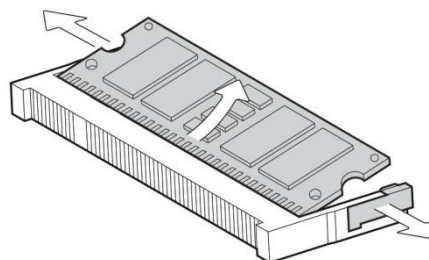

- Slide the memory module into the memory slot and press down until the ejector clips snaps in place.

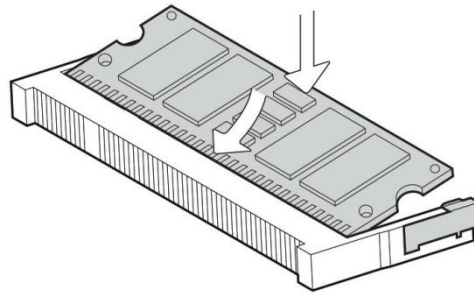

- Close up the System Cover.

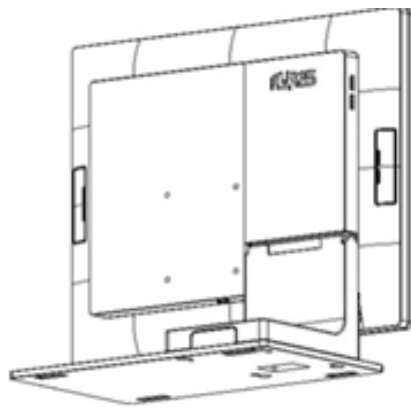

YUNO151 / 156 / 156-50KH

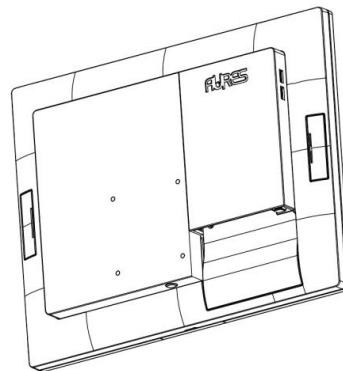

YUNO151K

### 3.4 Install the Power Adapter

The system is equipped with a 65W power adapter. Please follow below procedures to get it plugged into the system.

1. To open the System Cover, please refer to the procedures described in Chapter 3-1, and remove it.

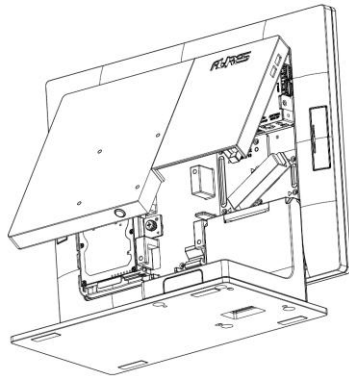

YUNO151 / 156 / 156-50KH

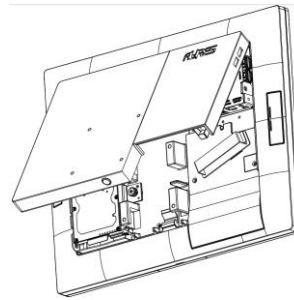

YUNO151K

2. Locate the power connector on the I/O panel (please refer to Chapter 2-5) and connect the plug of power adapter directly to the DC-IN jack. Route the DC cord connection securely.

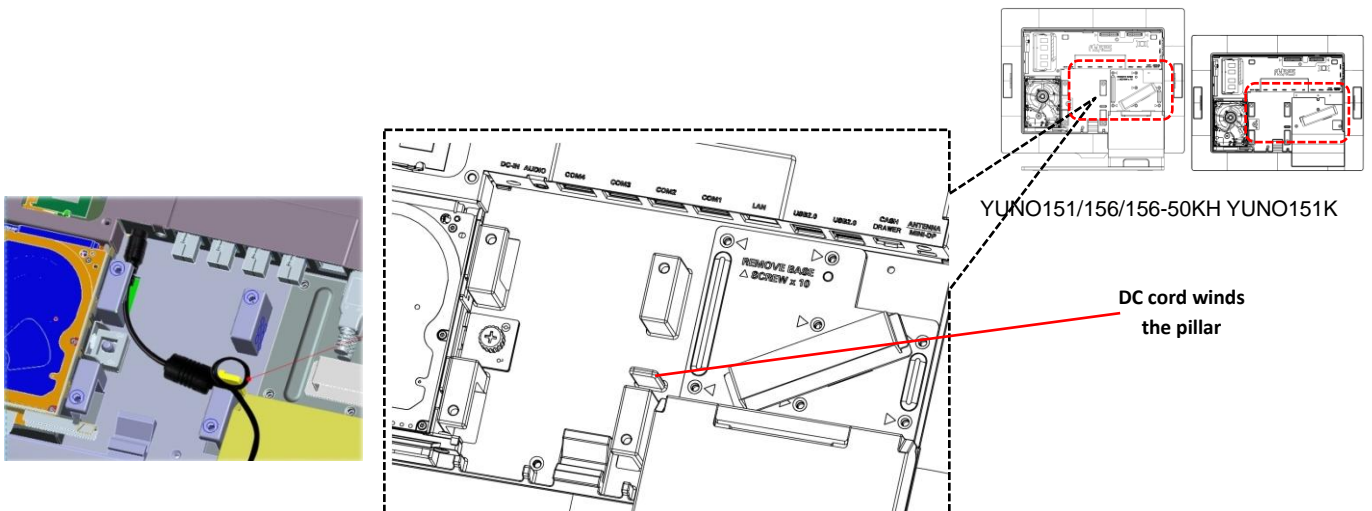

3. Remove the L-Stand / VESA Cover to locate the rest of DC cord properly.

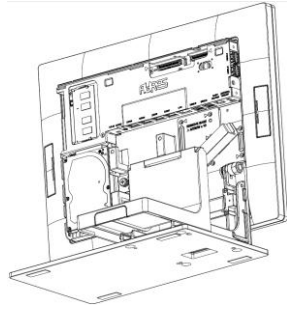

YUNO151 / 156 / 156-50KH

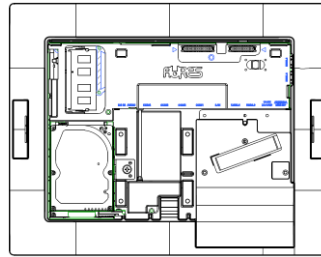

YUNO151K

4. After finish, slide in the L-Stand / VESA Cover and close up the System Cover.

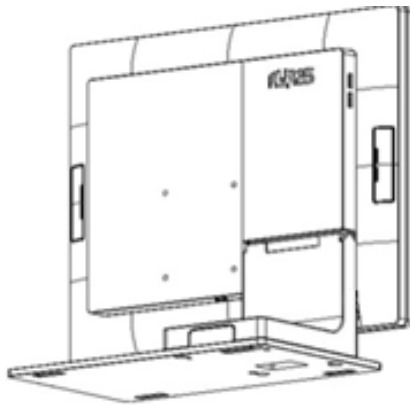

YUNO151 / 156 / 156-50KH

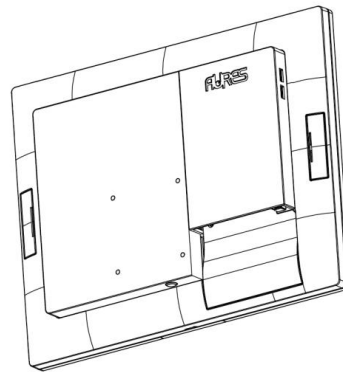

YUNO151K

### 3.5 Install the Wall-mount

Before you begin, make sure you have two screws that indicate a diameter measurement of 0.1377 inches (3.5mm).

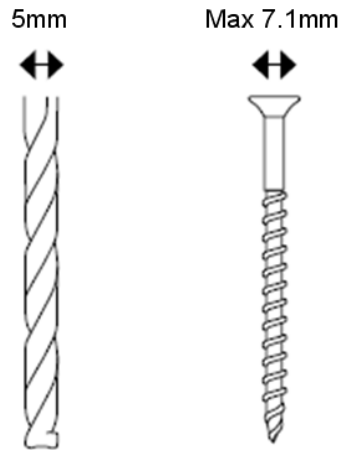

1. Determine where you want to mount the YUNO POS System series.
2. Drill two holes into the wall. Make sure adjacent holes are 2.95 inches (75mm) apart.
3. Insert a screw into each hole, and leave 0.2 inches (5mm) of its head exposed.
4. Maneuver the YUNO POS System series so the wall-mount slots line up with the two screws.
5. Place the wall-mount slots over the screws and slide the YUNO POS System series down until the screws fit snugly into the wall-mount slots.

YUNO POS System series follows VESA Mounting Interface Standard to allow you to mount the elegant bezel-free panel PC to a stand or wall with four M4 screws easily.

The horizontal and vertical distance between the tapped holes on YUNO POS System series is 75 mm.

Make sure the system is powered off before starting.

Please follow the below steps to get it ready for the mounting process :

1. Remove the System Cover.

To open the System Cover, please refer to the procedures described in Chapter 3-1, and remove it.

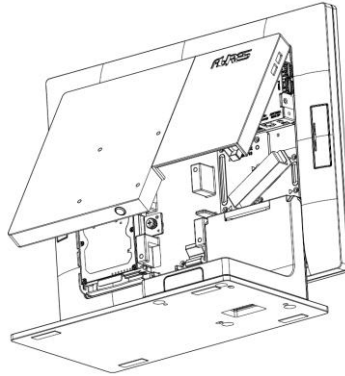

2. Remove the L-Stand Cover.

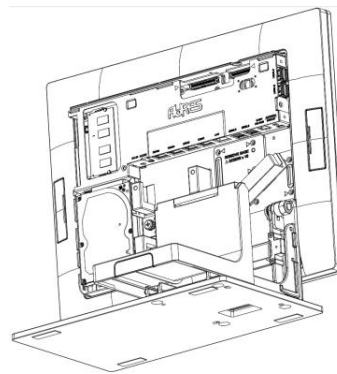

3. Detach the panel PC by unscrewing the **10** pcs of screws from the L-Stand Cover.

4. Remove the 4 pcs of rubber cap from the System Cover.

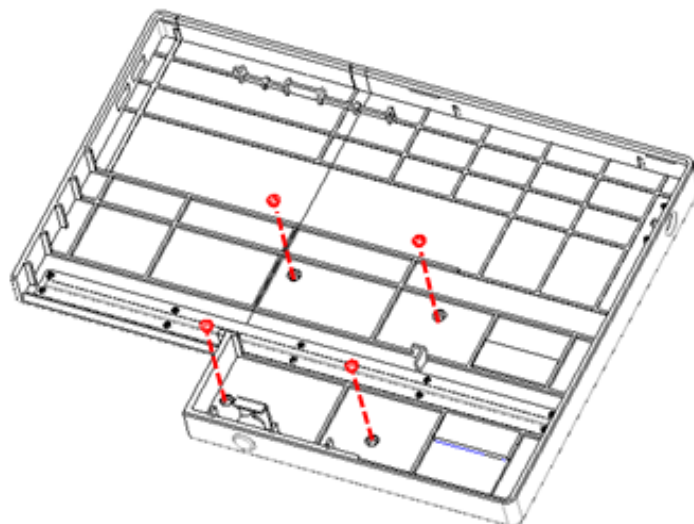



5. Get ready to the mounting process.

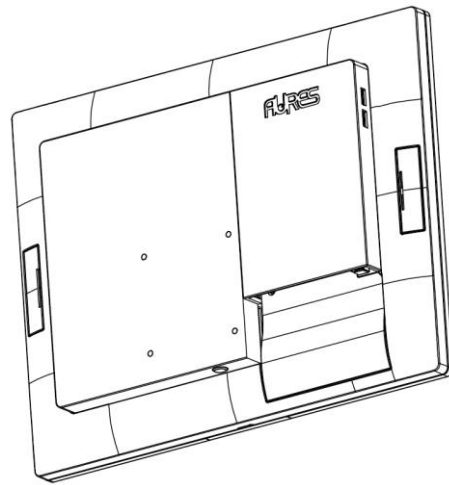

YUNO151 / 156 / 156-50KH and YUNO151K

Close up the System Cover and then mount it to a stand or wall with four M4 screws easily.

## 4. Peripherals Installation

### 4.1 Install the Cash Drawer

You can install a cash drawer through the cash drawer port.  
Please verify the pin assignment before installation.

#### Cash Drawer Pin Assignment

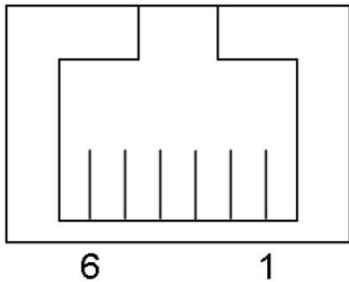

Pin	Signal
1	GND
2	DOUT bit0
3	DIN bit0
4	12V / 19V
5	DOUT bit1
6	GND

#### Cash Drawer Controller Register

The Cash Drawer Controller use one I/O addresses to control the Cash Drawer.

Register Location : 48Ch  
Attribute : Read / Write  
Size : 8-bit

BIT	BIT7	BIT6	BIT5	BIT4	BIT3	BIT2	BIT1	BIT0
Attribute	Reserved	Read	Reserved		Write		Reserved	

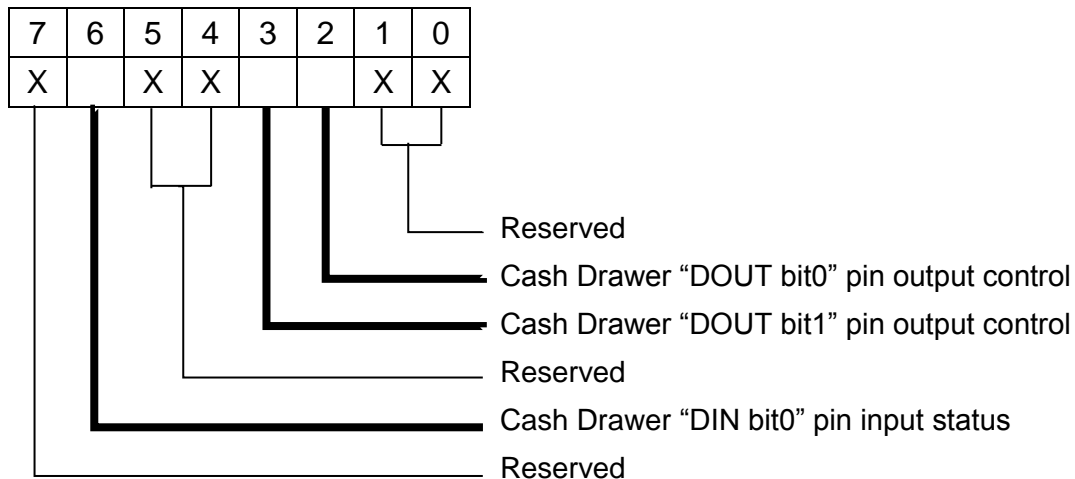

- BIT7: Reserved
- BIT6: Cash Drawer "DIN bit0" pin input status.  
= 1: the Cash Drawer closed or no Cash Drawer  
= 0: the Cash Drawer opened
- BIT5: Reserved
- BIT4: Reserved
- BIT3: Cash Drawer "DOUT bit1" pin output control.  
= 1: Opening the Cash Drawer  
= 0: Allow close the Cash Drawer
- BIT2: Cash Drawer "DOUT bit0" pin output control.  
= 1: Opening the Cash Drawer  
= 0: Allow close the Cash Drawer
- BIT1: Reserved
- BIT0: Reserved

Note: Please follow the Cash Drawer control signal design to control the Cash Drawer.

### Cash Drawer Control Command Example

Use Debug.EXE program under DOS or Windows98

Command	Cash Drawer
O 48C 04	Opening
O 48C 00	Allow to close
<ul style="list-style-type: none"> <li>➤ Set the I/O address 48Ch bit2 =1 for opening Cash Drawer by "DOUTbit0" pin control.</li> <li>➤ Set the I/O address 48Ch bit2 = 0 for allow close Cash Drawer.</li> </ul>	

Command	Cash Drawer
I 48C	Check status
<ul style="list-style-type: none"> <li>➤ The I/O address 48Ch bit6 =1 mean the Cash Drawer is opened or not exist.</li> <li>➤ The I/O address 48Ch bit6 =0 mean the Cash Drawer is closed.</li> </ul>	

## 4.2 Install the Attachment-type Customer Display (YUNO-VFD) and Second Display (YUNO-2NDLCD10.1)

The Attachment-type Customer Display (YUNO-VFD) and Second Display (YUNO-2NDLCD10.1) can be installed from the rear top side of the system. Make sure the unit is powered off before starting.

Please follow the below steps to finish the installation :

1. Unscrew the two pcs of screws from the rear top service door and remove it.
2. Connect the Customer Display cable with the connector of the system. Locate this connection properly.
3. Insert the Customer Display in place and fasten the two pcs of screws to make it secure.

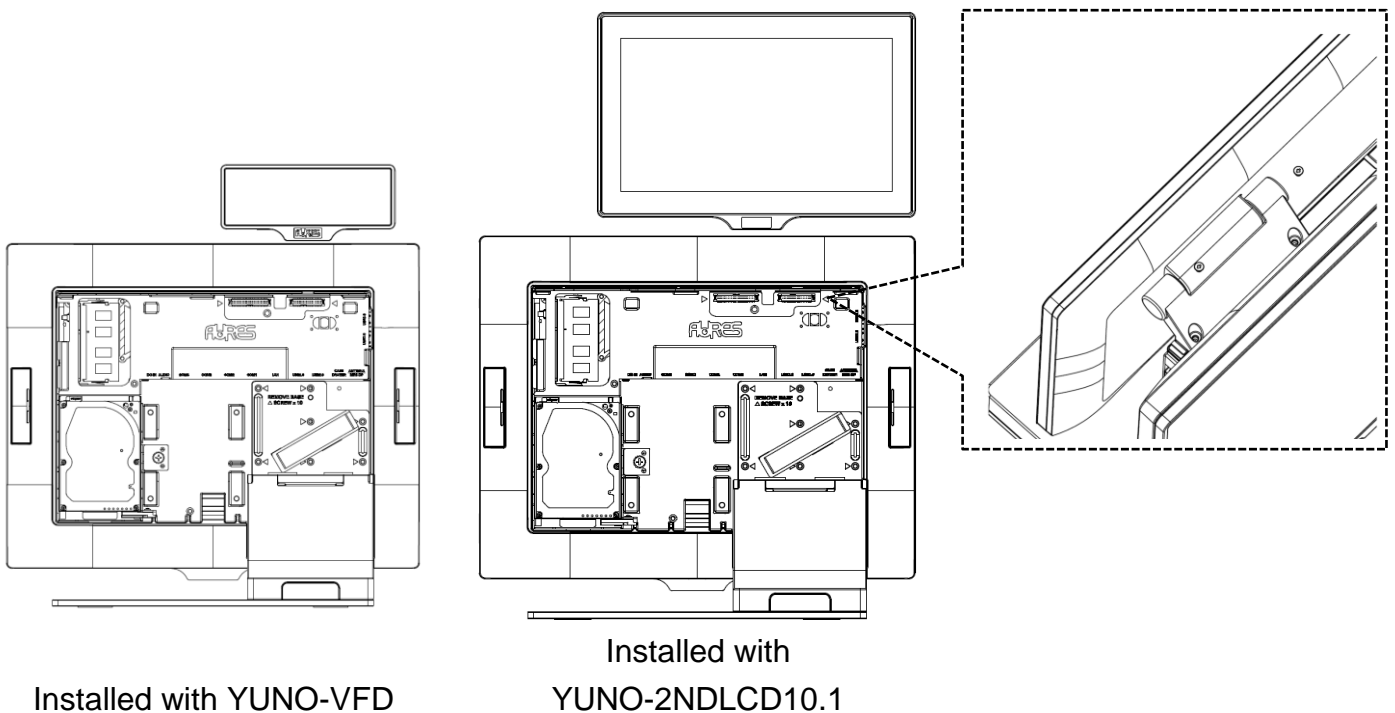

## 4.3 Install other Attachment-type Peripherals

Attachment-type peripherals, including YUNO-MSRLONG, YUNO-SCANNER2D, YUNO-DALLAS and YUNO-ADDIMAT Reader, may be easily installed at either side of the system. YUNO-MSRLONG is used as an installation representative for elaboration.

Make sure the unit is powered off before starting.

Please follow the below steps to finish the installation :

1. Unscrew the two pcs of screws from the selected side service door and remove its cover.
2. Place the Peripheral Adapter and connect the peripheral with the connector of the system. Locate this connection properly.

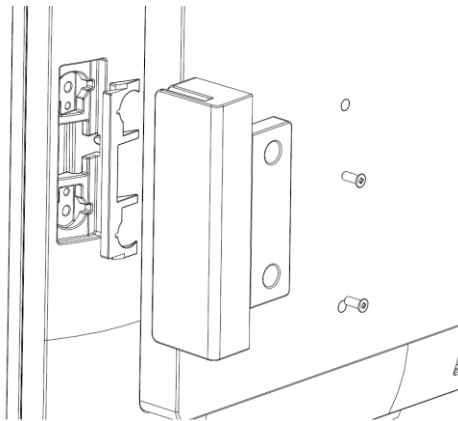

3. Insert the peripheral in place and fasten the two pcs of screws to make it secure.

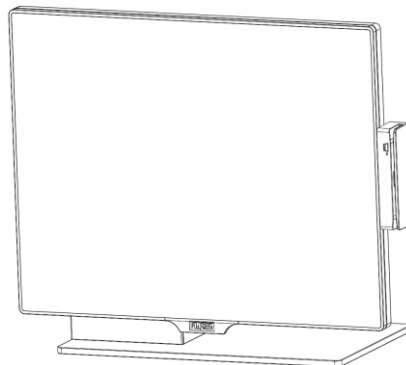

## 4.4 Install the Wi-Fi Bluetooth Module (YUNO-KIT-WIFI)

### 1. Package Content

- Intel® Dual Band Wireless-AC 3160 802.11ac, dual band, 1x1, Wi-Fi + Bluetooth 4.0 adapter (named as the “adapter” throughout the rest of this document)
- Wi-Fi Antenna
- Bluetooth Antenna

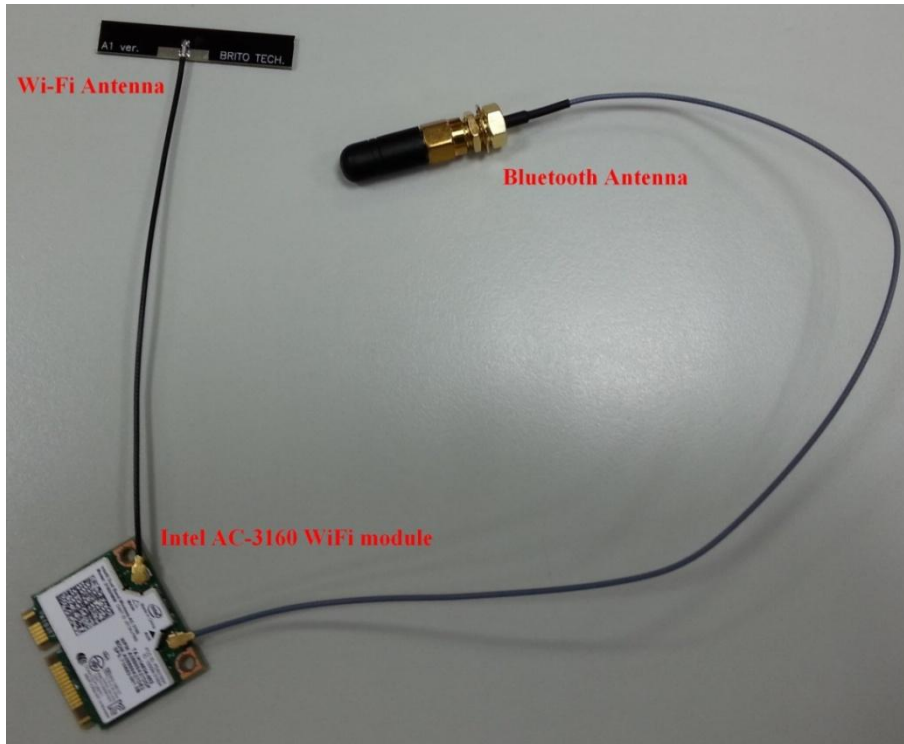

### 2. Before you begin



**Warning:** Avoid static discharge by grounding yourself using a wrist grounding strap or by touching a bare metal surface like a connector on the back of the system and remove all of the power including the battery and power adapter.

### 3. Tools needed

- 1 x small phillips head screwdriver

## 4. Installation and Removal Instructions

Make sure the system is powered off before starting.

### Step 1

- Detach the Kit Box from your YUNO POS system
- Remove two screws



- Remove the top cover



### Step 2

- Locate the Bluetooth Antenna at the right side of the Kit Box bottom cover and screw it securely

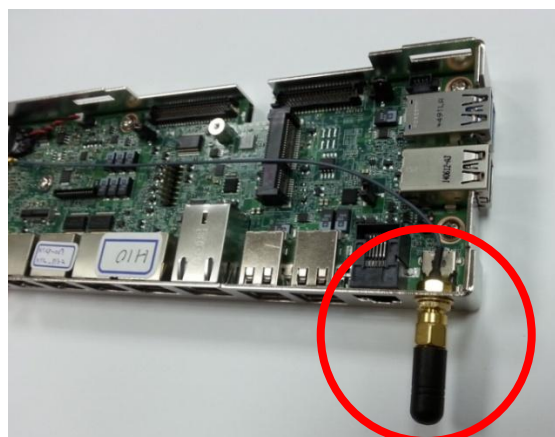

- Locate the Wi-Fi Antenna at the left side of the Kit Box top cover and glue it securely

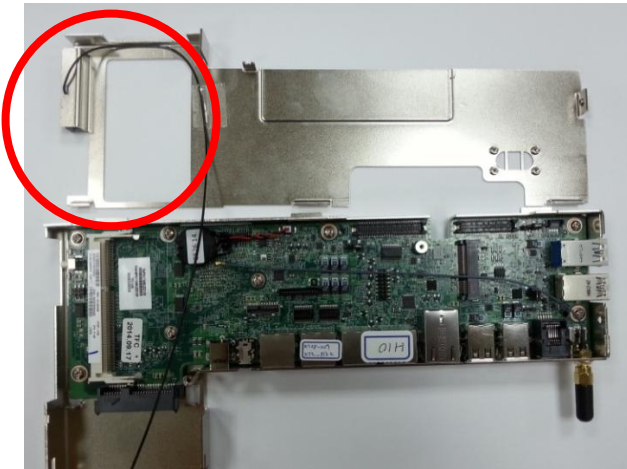

- Install the adapter on the mini PCI-E slot of the motherboard

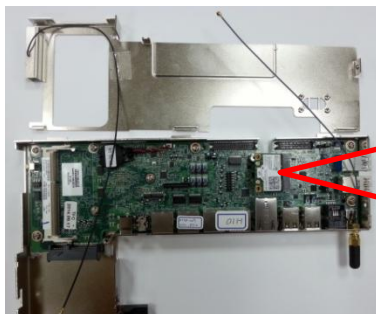

- Secure both connection wires of the two antenna with the adapter





### Step 3

- Locate the two connection wires properly and place back the top cover onto the Kit Box
- Secure the two screws properly



- Install the Kit Box back to YUNO POS system

\*Please refer to below link to download its device drivers per your needs :

<https://downloadcenter.intel.com/search?keyword=Intel%C2%AE+Dual+Band+Wireless-AC+3160>

## 5. Specification

Model Name	YUNO		
Model Number	YUNO151 / YUNO151K	YUNO156	YUNO156-50KH
CPU support	X72 motherboard (Bay Trail platform) : Intel® Bay Trail-D SoC Processor J1900 (2M Cache, up to 2.42 GHz)  X7D motherboard (Broadwell platform) : Intel® Core™ i3-5010U Processor (3M Cache, 2.10 GHz) Intel® Core™ i5-5350U Processor (3M Cache, up to 2.90 GHz) Intel® Core™ i7-5650U Processor (4M Cache, up to 3.20 GHz)		
System memory	1 x SO-DIMM DDR3L 1067/1333/1600, LPDDR3 1600/1866 Max 8~16GB (depends on motherboard installed in the system)		
LAN controller	RTL8111G PCI-E Gigabit LAN		
Audio controller	Realtek ALC662 HD Audio CODEC with 2-Channel		
Audio	2W Speaker x 2		
BIOS	Phoenix uEFI BIOS		
LCD Panel			
LCD size	15.0" (Innolux G150XGE-L05)	15.6" (LG LP156WHB-TLB1)	15.6" (AUO G156XW01_V3)
Brightness in cd/m <sup>2</sup>	250	200	400
Maximal resolution	1024 x 768	1366 x 768	
Aspect Ratio	4:3	16:9	
Backlight Type	LED	LED	
Touch Sensor			
P-CAP Touch	eTurboTouch SP-150M183647D4	eTurboTouch SP-156M183053D1	
Touch Screen	10	10	
Controller IC	Weida-8753	Weida-8753	
Interface	USB	USB	
Storage			
1st HDD / SSD	1 x 2.5" 7mm SATA HDD or SATA MLC SSD		
2nd SSD	1 x 2.5" 7mm SATA MLC SSD		
Side I/O			
Power Button	1 x with power indicator (blue color when power ON)		

USB	X72 motherboard : 1 x USB 2.0 and 1 x USB 3.0 X7D motherboard : 2 x USB 3.0
<b>Rear Bottom I/O</b>	
DC-IN jack	1 x radio jack connector for 19V DC input
Audio jack	1 x 4-conductor 3.5mm audio jack for MIC-in and Line-out
Serial / COM	4 x RJ50 connector with RJ50 to DB9 cable for RS-232 port - COM1/COM2: RS232, wake on ring (S1, S3, S4, S5) support
	- COM3/COM4: RS232, powered COM with BIOS select none (Default setting)/ +5V (Default) / +12V for DB9 pin9 by BIOS setting.
LAN	1 x RJ45 port for Gigabit Ethernet, support Wake on LAN
USB	4 x USB 2.0
Cash Drawer	1 x RJ12, support 12V / 24V DC Cash Drawer
Display Port	1 x mini Display Port (supporting active converter cable to VGA, DVI, HDMI)
<b>Power</b>	
Power Adapter	External 19V / 3.42A 65Watt Adapter
<b>Peripherals</b>	
Customer Display	Attachment-type via Serial COM6 (YUNO-VFD option)
Second Display	Attachment-type USB interface non-Touch and Touch models (YUNO-2NDLCD10.1 option)
Magnetic Stripe Reader	Attachment-type 3-Track USB Keyboard HID (YUNO-MSRLONG option)
2D Scanner	Attachment-type USB interface (YUNO-SCANNER2D option)
Dallas Key Reader	Attachment-type Keyboard and Serial emulation USB interface (YUNO-DALLAS option)
Addimat Key Reader	Attachment-type Keyboard and Serial emulation USB interface (YUNO-ADDIMAT option)
DC/DC Switching Power Adapter	Input 36Vdc to Output 19Vdc Switching Power Adapter (YUNO-ALIM-11/36V option)
Uninterruptible Power Supply Kit	19V DC Uninterruptible Power Supply Kit (YUNO-UPS option)

<b>Communication</b>		
Wireless LAN	2.4/5GHz, 802.11ac, a/b/g, n Wi-Fi Bluetooth Module (YUNO-KIT-WIFI option)	
<b>Certifications</b>		
EMI	FCC Class B / CE / LVD / RCM	
Safety	UL	
<b>Environment</b>		
Operating temperature	0°C ~ 35°C (32°F ~ 95°F)	
Storage temperature	-20°C ~ 60°C (-4°F ~ 140°F)	
Humidity	5% ~ 80%, non-condensing	
<b>Dimension (W x D x H)</b>	YUNO151 : LCD 90 degree : 360.1 x 171.5 x 316.1 mm  YUNO151K : 360.1 x 45 x 283.1 mm	LCD 90 degree : 402.2 x 171.5 x 295.3 mm
<b>Weight (N.W./G.W.)</b>	YUNO151 : 10kg / 11kg YUNO151K : 8.6kg / 9.6kg	YUNO156 : 11kg / 12kg YUNO156-50KH : 11.5kg / 12.5kg
<b>OS support</b>	Windows® 7 Professional for Embedded Systems, Windows® Embedded POSReady 7, Windows® Embedded 8.x Industry Retail Windows® 10 Industry	

\* This specification is subject to change without prior notice.

## 6. Configuration

### 6.1 X72 Motherboard

#### 6.1.1 Motherboard Layout

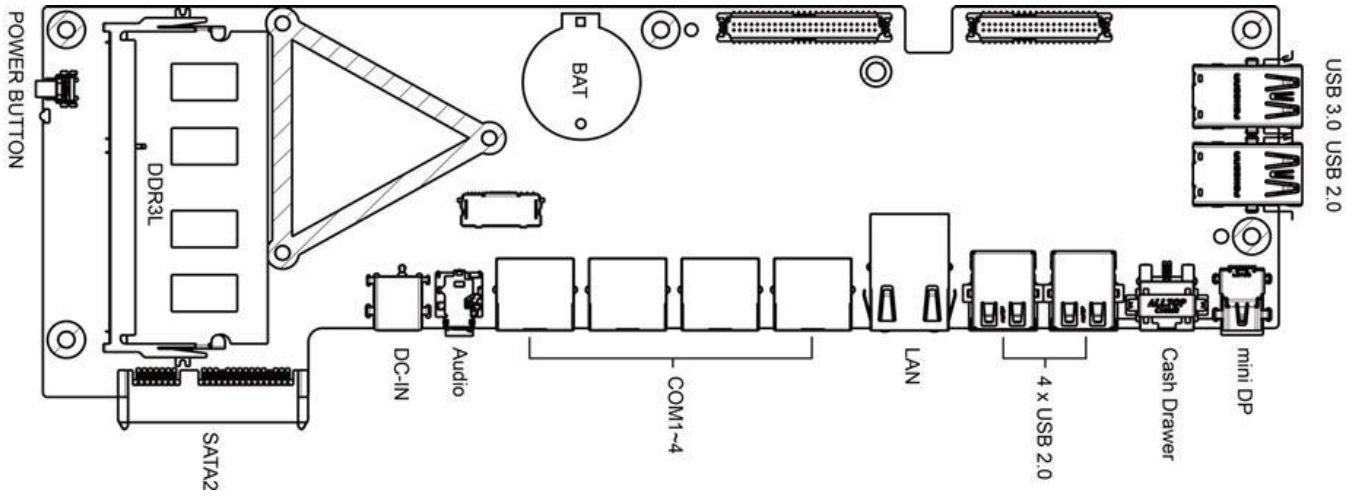

## 6.1.2 Connectors & Functions

Connectors	Functions
<b>Internal</b>	
LVDS1	50-pin connector
LVDS2	40-pin connector
HDD1	SATA power connector
HDD2	SATA power connector
INT_SP	Speaker connector
DIMM1	DDR3 SO-DIMM
CRT1	VGA connector (internal)
JP5	LCD Enable Level Select
JP6	LCD Power Select
JP7	RJ12 Power Select
<b>External</b>	
SW4	Power Button
DC-IN	DC-IN jack
CN11	3.5mm 4 conductor Audio jack (Combo MIC-in and Line-out)
COM1,COM2,COM3,COM4	RJ50 Serial Ports
LAN_CON1	LAN port
USB_CON1	USB2.0 port0/1
USB_CON2	USB2.0 port2/3
RJ12	Cash Drawer
MINI_DP1	mini DP (Display Port)
USB30_1	USB3.0 port0/1
USB20_3	USB2.0 port4/5

### 6.1.3 Jumper Settings

#### LCD Enable Level Select

Function	JP5 (1-2)(2-3)
+5V	<input type="checkbox"/> 1 <input checked="" type="checkbox"/> 2 <input type="checkbox"/> 3
+3.3V (Default)	1 <input type="checkbox"/> 2 <input checked="" type="checkbox"/> 3

#### LCD Power Select

Function	JP6 (1-2)(2-3)
+5V	<input type="checkbox"/> 1 <input checked="" type="checkbox"/> 2 <input type="checkbox"/> 3
+3.3V (Default)	1 <input type="checkbox"/> 2 <input checked="" type="checkbox"/> 3

#### RJ12 Cash drawer Power Select

Function	JP7 (1-2)(2-3)
+19V (Default)	<input type="checkbox"/> 1 <input checked="" type="checkbox"/> 2 <input type="checkbox"/> 3
+12V	1 <input type="checkbox"/> 2 <input checked="" type="checkbox"/> 3

SHORT     OPEN

## 6.2 X7D Motherboard

### 6.2.1 Motherboard Layout

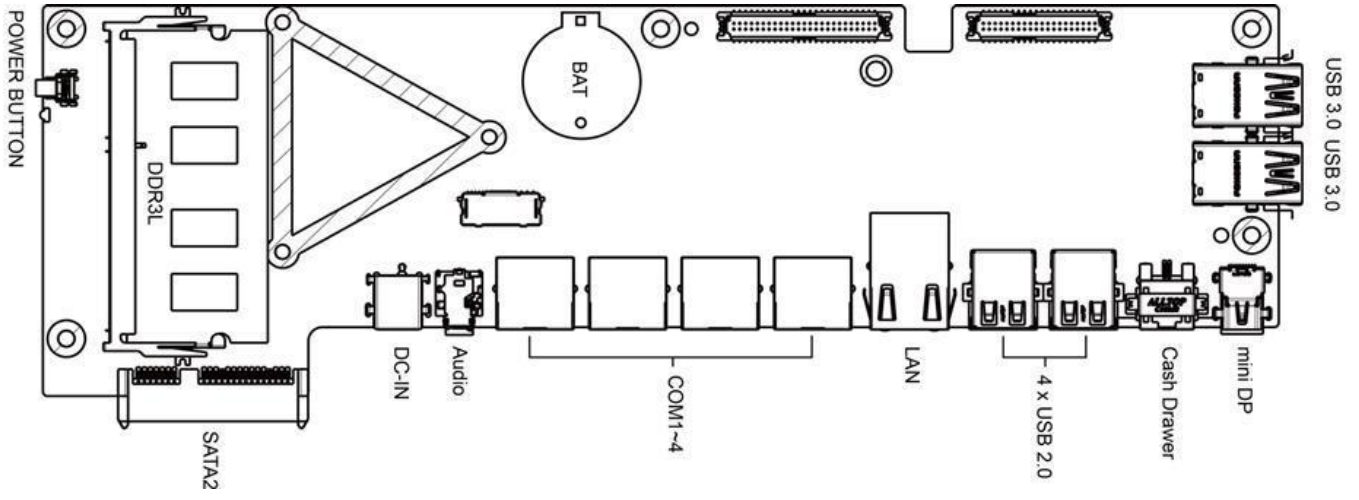



## 6.2.2 Connectors & Functions

Connectors	Functions
<b>Internal</b>	
LVDS2	50-pin connector
LVDS1	40-pin connector
HDD1	SATA power connector
HDD2	SATA power connector
INT_SP	Speaker connector
DIMM1	DDR3 SO-DIMM
JP3	LCD Enable Level Select
JP2	LCD Power Select
JP1	RJ12 Power Select
<b>External</b>	
SW1	Power Button
DC-IN	DC-IN jack
CN1	3.5mm 4 conductor Audio jack (Combo MIC-in and Line-out)
COM1,COM2,COM3,COM4	RJ50 Serial Ports
LAN_CON1	LAN port
USB_CON1	USB2.0 port0/1
USB_CON2	USB2.0 port2/3
RJ1	Cash Drawer
MINI_DP1	mini DP (Display Port)
USB30_1	USB3.0 port0/1
USB20_1	USB3.0 port4/5

### 6.2.3 Jumper Settings

#### LCD Enable Level Select

Function	JP3 (1-2)(2-3)
+5V	<input type="checkbox"/> 1 <input checked="" type="checkbox"/> 2 <input type="checkbox"/> 3
+3.3V (Default)	1 <input type="checkbox"/> 2 <input checked="" type="checkbox"/> 3

#### LCD Power Select

Function	JP2 (1-2)(2-3)
+5V	<input type="checkbox"/> 1 <input checked="" type="checkbox"/> 2 <input type="checkbox"/> 3
+3.3V (Default)	1 <input type="checkbox"/> 2 <input checked="" type="checkbox"/> 3

#### RJ12 Cash drawer Power Select

Function	JP1 (1-2)(2-3)
+19V (Default)	<input type="checkbox"/> 1 <input checked="" type="checkbox"/> 2 <input type="checkbox"/> 3
+12V	1 <input type="checkbox"/> 2 <input checked="" type="checkbox"/> 3

SHORT     OPEN

## Appendix A: Driver Installation

To download the most recent drivers and utilities, and obtain advice regarding the installation of your equipment, please visit the AURES Technical Support Website:

**[www.ares-support.fr](http://www.ares-support.fr)(French)**

**[www.ares-support.fr/UK](http://www.ares-support.fr/UK)(English)**

**[www.ares-support.fr/GE](http://www.ares-support.fr/GE)(German)**

# 1. Installation Note of USB 3.0 Driver with Bay Trail YUNO

Please follow below steps to make YUNO able to access USB 3.0 devices.

Step 1. Enter "Advanced" Tab

Select "South Cluster Configuration"

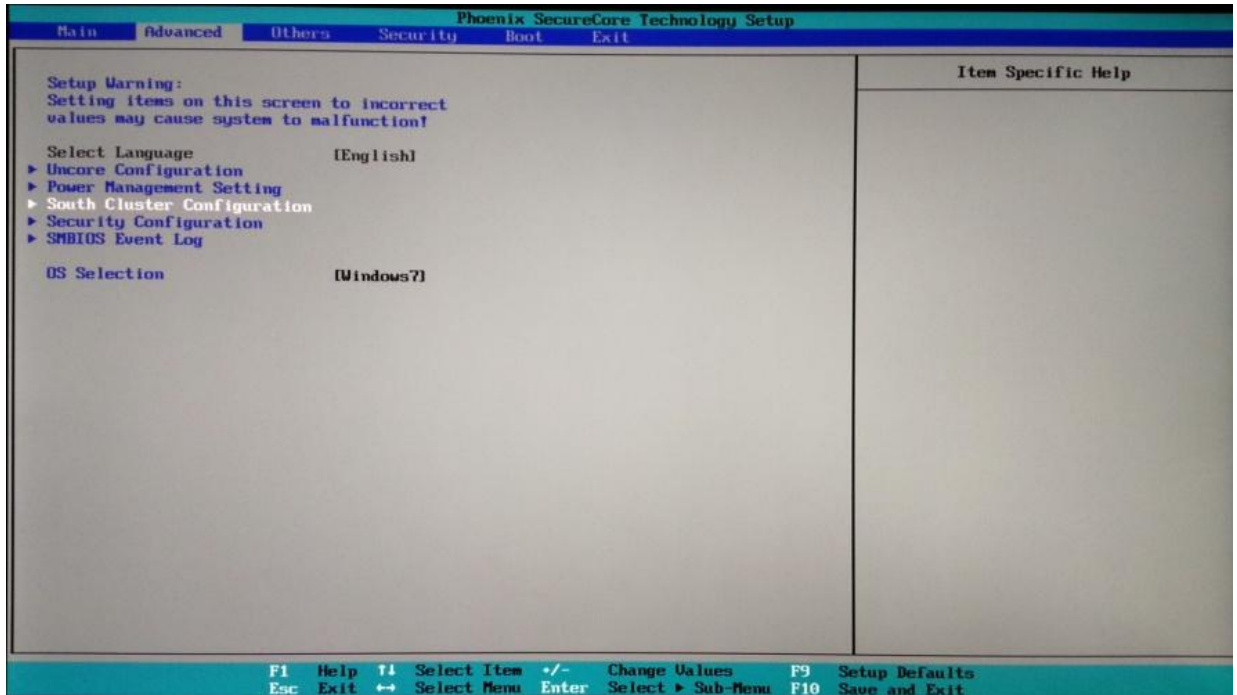

Step 2. Select "USB Configuration"

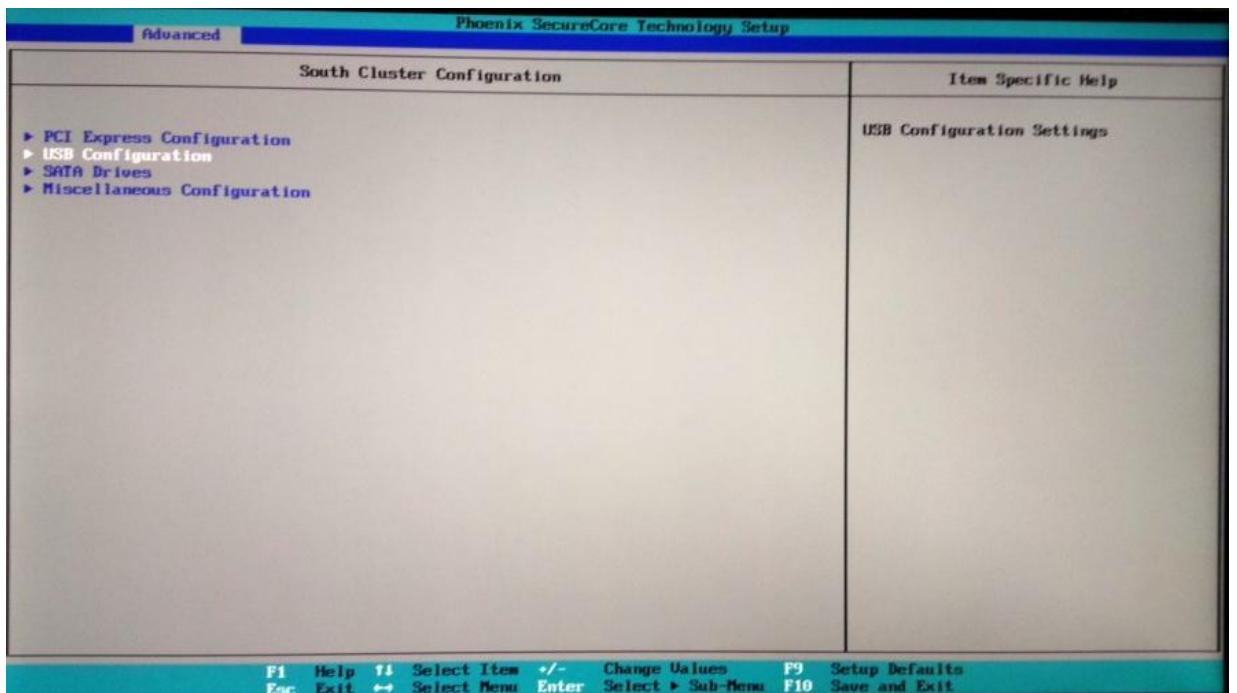

**Step 3. Set xHCI Mode → Smart Auto**

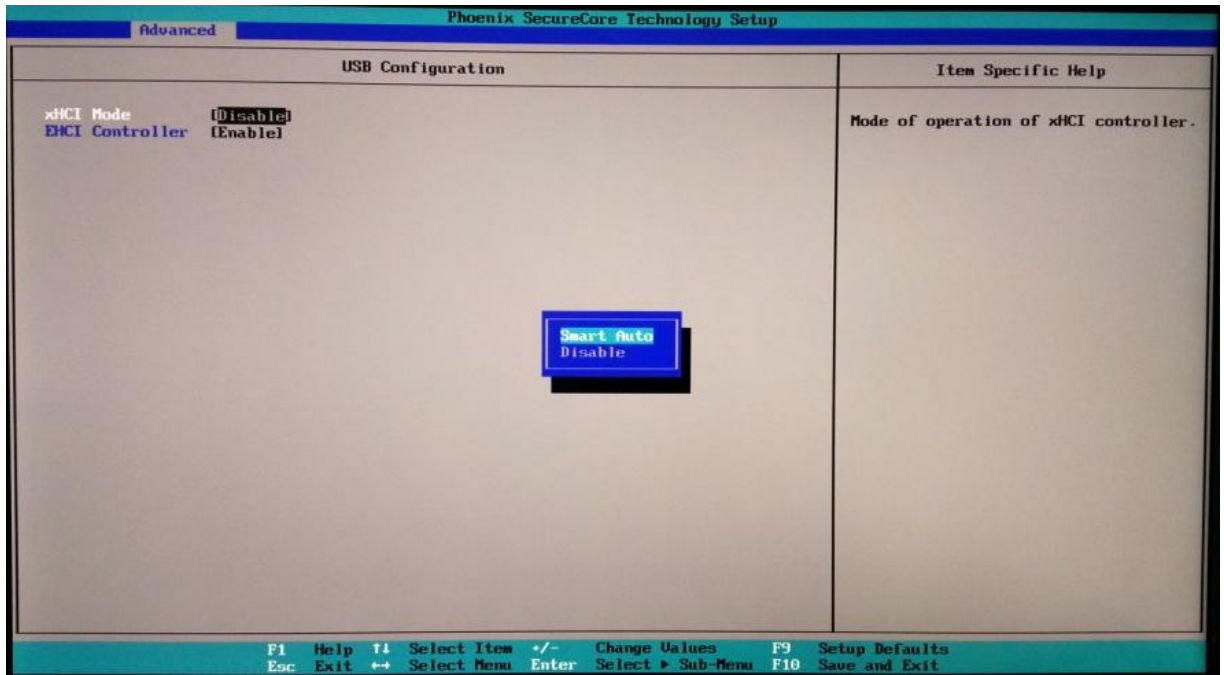

**Step 4. Save the above settings and boot into POS Ready 7 or Windows 7**

**Step 5. Install USB 3.0 driver on POS Ready 7 or Windows 7**

## Install Windows OPK

Install USB 3.0 driver at POSReady 7 DVD “sources” folder boot.wim.

```
Dism /mount-wim /wimfile:f:\sources\boot.wim /mountdir:e:\winpeusb30 /index:1
```

Tips:

```
/wimfile:f:\sources\boot.wim
```

→this is the POSReady 7 DVD “sources” folder file name “boot.wim”

```
/mountdir:e:\winpeusb30
```

→this is a temporary folder. It could be drive : c, or drive : d, as you create and name it.

```
/index:1
```

→this is always 1.

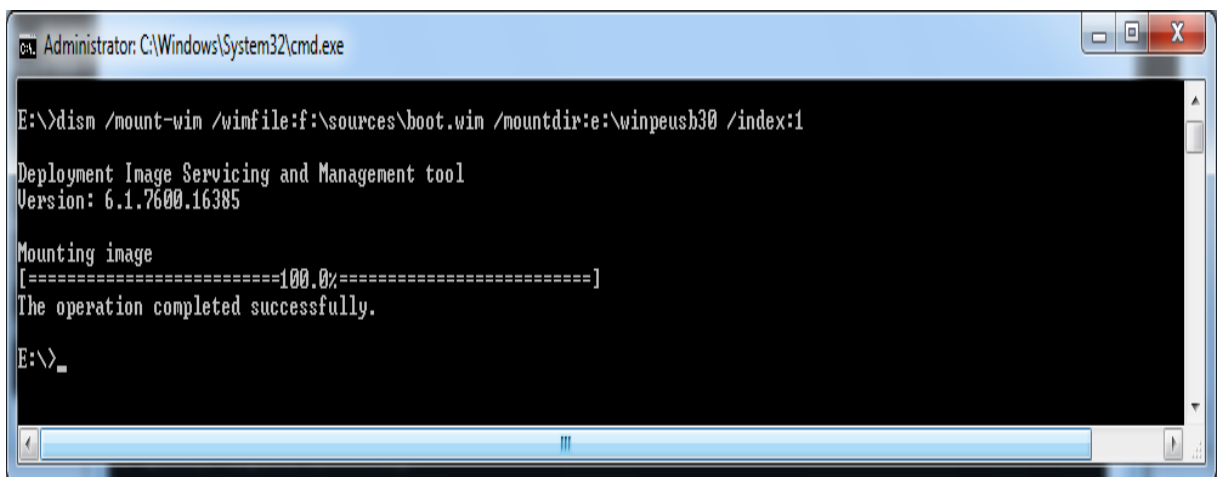

```
Administrator: C:\Windows\System32\cmd.exe

E:\>dism /mount-wim /wimfile:f:\sources\boot.wim /mountdir:e:\winpeusb30 /index:1

Deployment Image Servicing and Management tool
Version: 6.1.7600.16385

Mounting image
[=====100.0%=====]
The operation completed successfully.

E:\>_
```

Dism /image:e:\winpeusb30 /add-driver /driver:f:\test\setupusb3\drivers /recurse

Tips:

/image:e:\winpeusb30

➔this is a temporary folder.

/driver:f:\test\setupusb3\drivers

➔this is the USB 3.0 driver folder

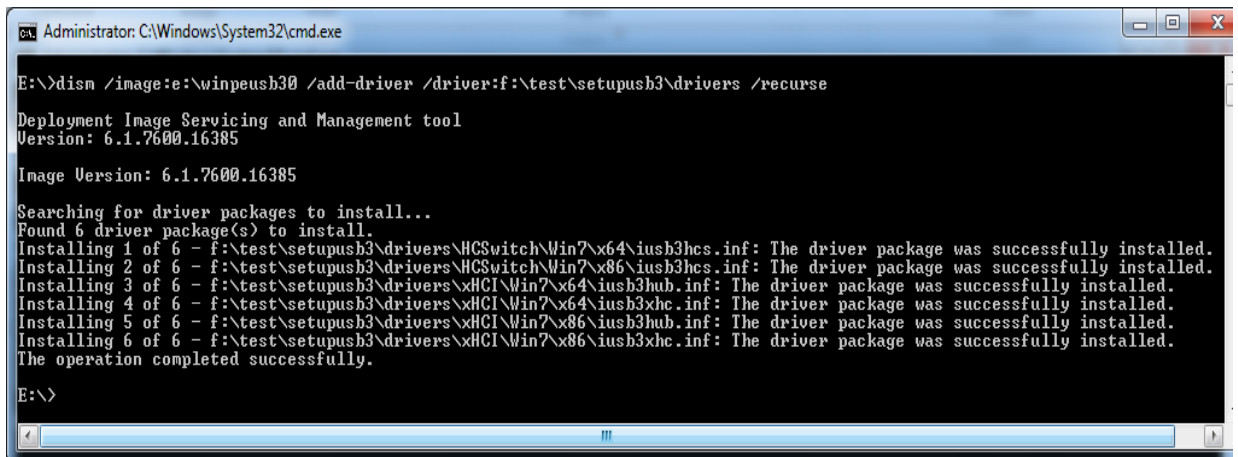

```
Administrator: C:\Windows\System32\cmd.exe
E:\>dism /image:e:\winpeusb30 /add-driver /driver:f:\test\setupusb3\drivers /recurse
Deployment Image Servicing and Management tool
Version: 6.1.7600.16385

Image Version: 6.1.7600.16385

Searching for driver packages to install...
Found 6 driver package(s) to install.
Installing 1 of 6 - f:\test\setupusb3\drivers\HCSwitch\Win7\x64\iusb3hcs.inf: The driver package was successfully installed.
Installing 2 of 6 - f:\test\setupusb3\drivers\HCSwitch\Win7\x86\iusb3hcs.inf: The driver package was successfully installed.
Installing 3 of 6 - f:\test\setupusb3\drivers\xHCI\Win7\x64\iusb3hub.inf: The driver package was successfully installed.
Installing 4 of 6 - f:\test\setupusb3\drivers\xHCI\Win7\x64\iusb3xhc.inf: The driver package was successfully installed.
Installing 5 of 6 - f:\test\setupusb3\drivers\xHCI\Win7\x86\iusb3hub.inf: The driver package was successfully installed.
Installing 6 of 6 - f:\test\setupusb3\drivers\xHCI\Win7\x86\iusb3xhc.inf: The driver package was successfully installed.
The operation completed successfully.

E:\>
```

Dism /unmount-wim /mountdir:e:\winpeusb30 /commit

Tips:

/image:e:\winpeusb30

→this is a temporary folder.

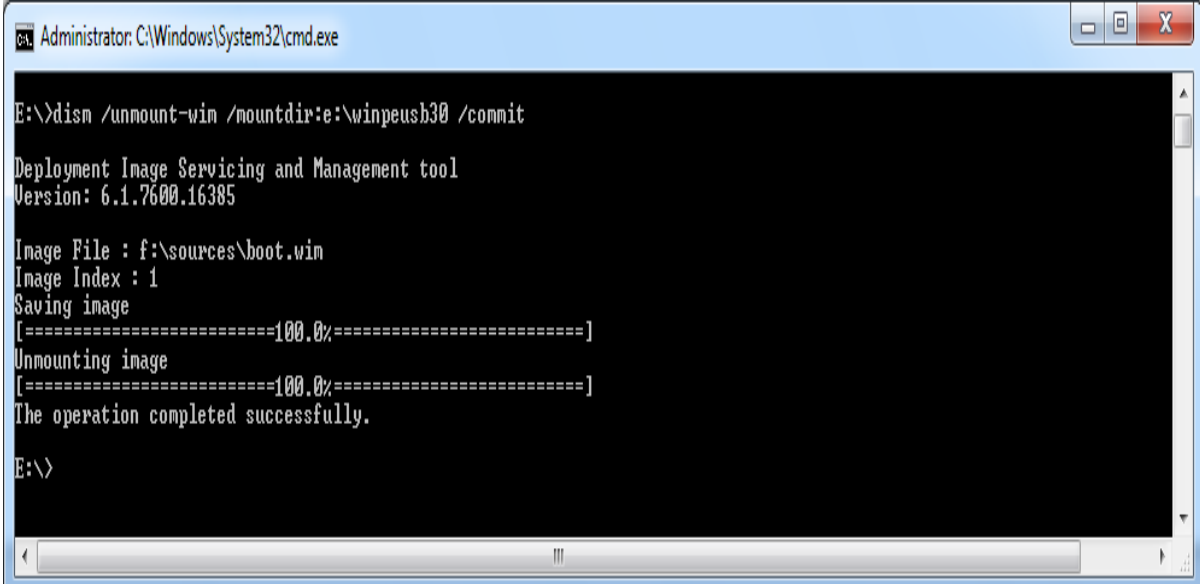

```
Administrator: C:\Windows\System32\cmd.exe
E:\>dism /unmount-wim /mountdir:e:\winpeusb30 /commit
Deployment Image Servicing and Management tool
Version: 6.1.7600.16385
Image File : f:\sources\boot.win
Image Index : 1
Saving image
[=====100.0%=====]
Unmounting image
[=====100.0%=====]
The operation completed successfully.
E:\>
```

During install the POSReady 7, there will have an installation of additional driver option.

Please select it and install additional USB 3.0 driver.

Or, follow the above step to install USB 3.0 at POSReady 7 DVD “sources” folder file name “install.wim”.



After installation of Windows 7 USB 3.0 driver, reboot and enter BIOS setup menu to change following setting to make USB 3.0 driver with xHCI Mode effect.

Enter "**Advanced**" Tab, select "**South Cluster Configuration**", select "**USB Configuration**".

Step 5. Setting **EHCI Controller** → **Disable**

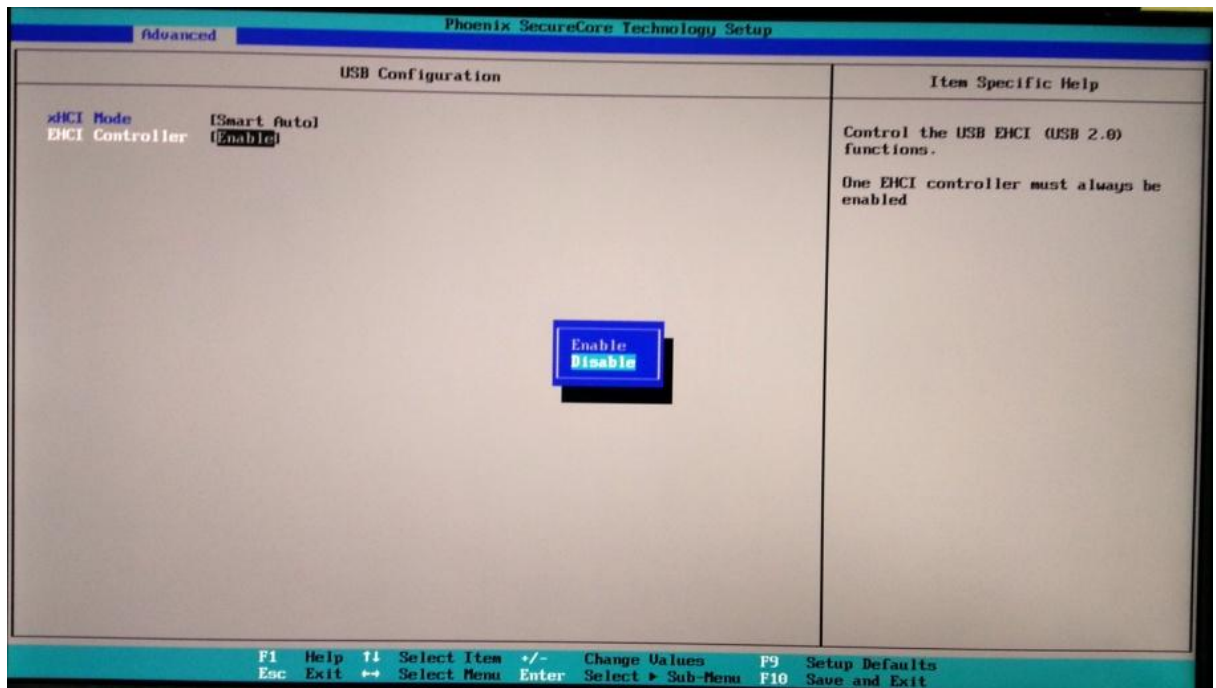

Step 6. Setting **xHCI Mode** → **Enable**

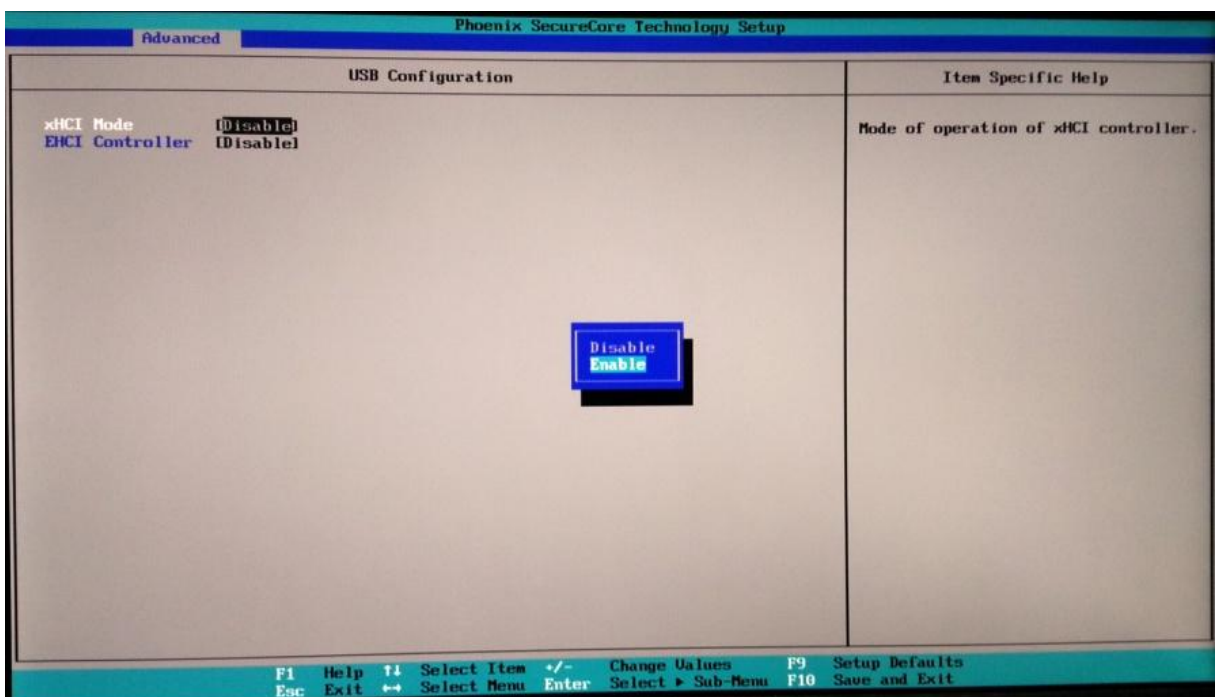

## 2. Application Note of installing POSReady 7 or Windows 7 with Broadwell YUNO

Please follow below steps to install POSReady 7 or Windows 7 with Broadwell YUNO.

Step 1. XHCI option (Advanced – USB Configuration) needs to be set at “Auto” in BIOS, and then start to install POSReady 7 or Windows 7.

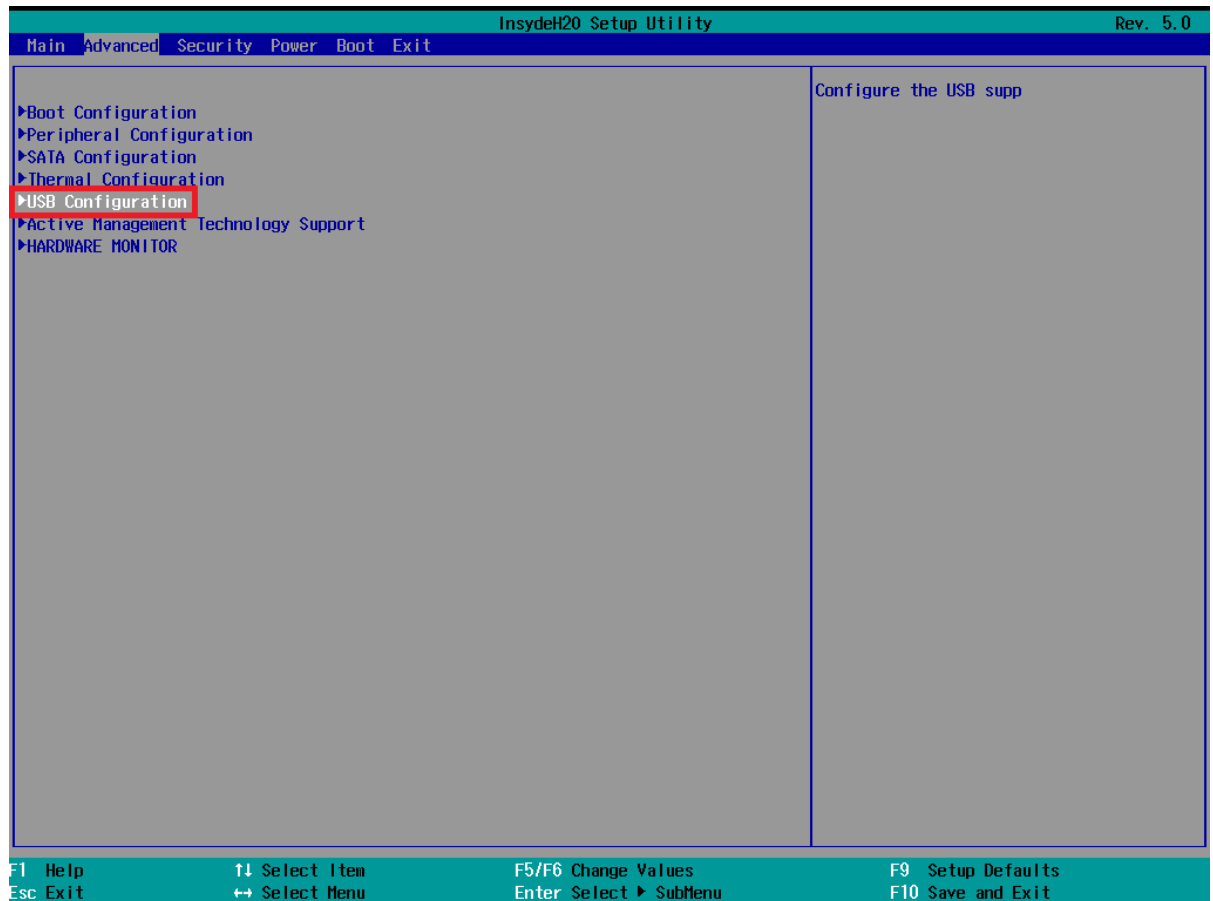

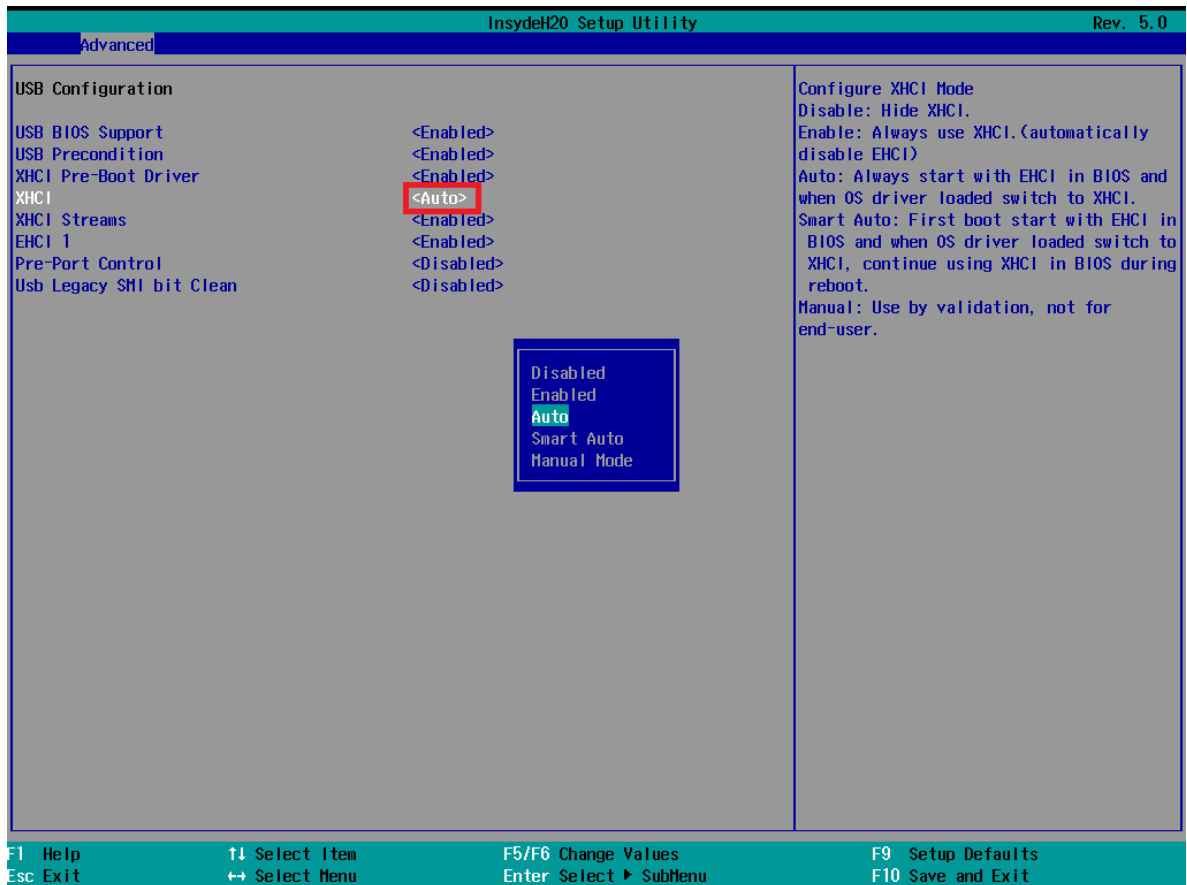

Step 2. When the installation is completed, please install all the drivers (including USB 3.0 driver)

Step 3. When USB 3.0 driver has been installed, the XHCI option has to be set to “Enabled” in BIOS.

## Appendix B: Customer Display Command Settings (F/W : v1.06)

### 1. FEATURES

- (1) Data can be displayed on 20 columns x 2 lines.
- (2) Blue-green color and large characters are easy to eye.s
- (3) The commands modes, fonts, baud rate and other parameters are selected by software.
- (4) CD5220 / UTC / EMAX / ADM / EscPOS / DSP-800 emulation command sets.
- (5) User-defined characters can be downloaded  
(for EscPOS /CD5220/DSP-800 command).
- (6) Provides an interface based on RS-232C or USB  
(baud rate: 4800, 9600, 19200, 38400, 115200 bps).
- (7) Powered by 5V.

## 2. GENERAL SPECIFICATIONS

No	Item	Description
1	Display method	Vacuum fluorescent display
2	Number of character	40 characters ( 20 columns x 2 lines)
3	Character font	5 x 7 dot matrix
4	Display color	Blue green
5	Brightness	~ 500 cd/m <sup>2</sup>
6	Character type	96 alphanumeric 13 kinds of international character set 1 kind of user define character
7	Character size	9.03 mm x 5.25 mm
8	Power supply	5 V
9	Power consumption	2.3W (Max.)
10	MTBF	25,000 hours
11	Module dimensions	146 (W) x 49.2 (H) x 15.2 (D) mm
12	Weight	85g
13	Operating temperature	0 ~ 45°C
14	Operating Humidity	30% ~ 85%
15	Storage Temperature	-10 ~ 50°C
16	Storage Humidity	10% ~ 90%

### 3. INTERFACE

#### 3.1 RS-232C Specifications

Data transmission	Serial
Synchronization	Asynchronous
Handshaking	DTR / DSR
Signal level	MARK = -3 to -15 V (logic "1") SPACE = +3 to +15 V (logic "0")
Baud rates	4800,9600,19200,38400 or 115200 bps
Parity and bit length	None parity, 8 data bits or Even parity, 7 data bits
Stop bits	1 or more

Note: There are 200 bytes resident buffer in the display for pass data to printer. If PC/host keep transmitting the data to printer when the display is inactive DTR or RTS, data will be lost.

## 4. CONNECTOR AND JUMPER

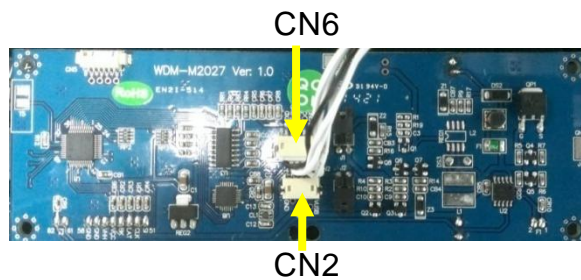

### 4.1 RS232C connector (CN6)

Connector type: JST/ZH/1.5mm/6P  
Pin assignment



No	Signal	Direction	Function Description
1	TXD	From display to PC/Host	
2	RXD	From PC/Host to display	
3	RTS	From display to PC/Host	
4	CTS	From PC/Host to display	
5	GND	-	Signal ground
6	Vin	-	Power 5 Vdc

### 4.2 USB connector (CN2)

Connector type: JST/ZH/1.5mm/4P  
Pin assignment

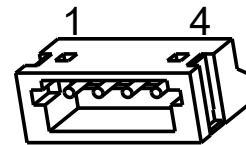

No	Signal	Direction	Function Description
1	GND	-	Signal ground
2	USBD+	-	USB data signal +
3	USBD-	-	USB data signal -
4	5Vdc	5V From PC/Host	Power 5 Vdc

### 4.3 ON/OFF Switch Connector

Type: JST/XH/2.5mm/2P



Location	SHORT	OPEN
J1	RS232 enable	RS232 disable
J2	USB enable	USB disable

## 5. COMMAND

### 5.1 CD5220 Standard Mode Command List

Command	Code (hex)	Function Description
ESC DC1	1B 11	Overwrite mode
ESC DC2	1B 12	Vertical scroll mode
ESC DC3	1B 13	Horizontal scroll mode
ESC QA ....CR	1B 51 41 <i>data</i> x m OD	Set the string display mode, write string to upper line $m \leq 20$
ESC QB ....CR	1B 51 42 <i>data</i> x m OD	Set the string display mode, write string to lower line $m \leq 20$
ESC QD ....CR	1B 51 44 <i>data</i> x m OD	Upper line message scroll continuously $m \leq 40$
ESC [ D	1B 5B 44	Move cursor left
BS	08	Move cursor left
ESC [ C	1B 5B 43	Move cursor right
HT	09	Move cursor right
ESC [ A	1B 5B 41	Move cursor up
ESC [ B	1B 5B 42	Move cursor down
LF	0A	Move cursor down
ESC [ H	1B 5B 48	Move cursor to home position
HOM	0B	Move cursor to home position
ESC [ L	1B 5B 4C	Move cursor to left-most position
CR	0D	Move cursor to left-most position
ESC [ R	1B 5B 52	Move cursor to right-most position
ESC [ K	1B 5B 4B	Move cursor to bottom position
ESC   x y	1B 6C x y	Move cursor to specified position $1 \leq x \leq 20$ ,row position $1 \leq y \leq 2$ ,column position
ESC @	1B 40	Initialize display
CLR	0C	Clear display screen , and clear string mode
CAN	18	Clear cursor line, and clear string mode
ESC * n	1B 2A n	Brightness adjustment $1 \leq n \leq 4$



ESC & s n m [a (P1..pa)]x (m-n+1)	1B 26 1 n m [a(p1..pa)] x (m-n+1)	Define download characters. $32 \leq n \leq m \leq 255$ $1 \leq a \leq 5$ p1..p5 = row1..row5
ESC ? n	1B 3F n	Deletes download characters. $32 \leq n \leq m \leq 255$
ESC % n	1B 25 n	Select/cancel download character set. n = 0 , Cancel n = 1 , Select
ESC _ n	1B 5F n	Set cursor on/off n = 1 , cursor on n = 2 , cursor off
ESC f n	1B 66 n	Select international fonts set, refer *2
ESC c n	1B 63 n	Select code, refer *3
ESC = n	1B 3D n	Select peripheral device, display or printer n bit 0 = 1 select printer n bit 1 = 1 select display

\*REMARK :

\*1 The parameter of international fonts set control by command “ESC f n”

Parameter “n”	International font set
“A”	U.S.A.
“G”	Germany
“I”	Italy
“J”	Japan
“U”	U.K.
“F”	France
“S”	Spain
“N”	Norway
“W”	Sweden
“D”	Denmark I
“E”	Denmark II
“L”	Slavonic
“R”	Russia

\*2 The parameter of the code table control by command “ESC c n”

Parameter “n”	International font set
“A”	Compliance with ASCII code
“J”	Compliance with JIS code
“L”	Compliance with SLAVONIC code
“R”	Compliance with RUSSIA code

## 5.2 UTC standard mode command list

Command	Code (hex)	Function Description
EOT n	04 n	Display Dimming n = 20h, 40h, 60h, FFh
BS	08	Back space
HT	09	Horizontal tab
LF	0A	Line feed
CR	0D	Carriage return
DLE	0F	Display position
DC1	11	Over write display mode
DC2	12	Vertical scroll mode
DC3	13	Cursor on
DC4	14	Cursor off
CAN	18	Clear to end of line
EM	19	Clear to end of display
FS	1C	Flashing text start
GS	1D	Flashing text end
US	1F	Reset display
RS	1E	Home and clear display
ESC d	1B 64	Change to UTC enhanced mode

### 5.3 UTC enhanced mode command list

Command	Code (hex)	Function Description
SI	0F	Flashing text start
SO	0E	Flashing text stop
ESC u A ..CR	1B 75 41 <i>data</i> x m 0D	Upper line display $0 \leq m \leq 20$
ESC u B ..CR	1B 75 42 <i>data</i> x m 0D	Bottom line display $0 \leq m \leq 20$
ESC u D ..CR	1B 75 44 <i>data</i> x m 0D	Upper line message scroll continuously $0 \leq m \leq 40$
ESC u E ..CR	1B 75 45 "hh:mm" 0D	Display time '00' $\leq$ hh $\leq$ '23' '00' $\leq$ mm $\leq$ '59'
ESC u F ..CR	1B 75 46 <i>data</i> x m 0D	Upper line message scroll once pass
ESC u H ..CR	1B 75 48 n m 0D	Change attention code $32 \leq n \leq 255$ $32 \leq m \leq 255$
ESC u I ..CR	1B 75 49 <i>data</i> x m 0D	Two line display $0 \leq m \leq 40$
ESC RS CR	1B 0F 0D	Change to UTC standard mode

## 5.4 AEDEX mode command list

Command	Code (hex)	Function Description
! # 1 ....CR	21 23 31 <i>data</i> x m OD	Upper line display $0 \leq m \leq 40$
! # 2 ....CR	21 23 32 <i>data</i> x m OD	Bottom line display $0 \leq m \leq 40$
! # 4 ....CR	21 23 34 <i>data</i> x m OD	Upper line message scroll continuously $0 \leq m \leq 40$
! # 5 ....CR	21 23 35 "hh:mm" OD	Display time '00' $\leq$ hh $\leq$ '23' '00' $\leq$ mm $\leq$ '59'
! # 6 ....CR	21 23 36 <i>data</i> x m OD	Upper line message scroll one pass $0 \leq m \leq 40$
! # 8 ....CR	21 23 38 n m OD	Change attention code $32 \leq n \leq 255$ $32 \leq m \leq 255$
! # 9 ....CR	21 23 39 <i>data</i> x m OD	Two line display $0 \leq m \leq 40$

## 5.5 PD3000 mode command list

Command	Code (hex)	Function Description
DC2	12	Vertical Scroll Mode
DC1	11	Normal Display Mode
EOT	04	Brightness Control
BS	08	Back Space
HT	09	Horizontal Tab
LF	0A	Line Feed
CR	0D	Carriage Return
DLE	10	Digit Select
DC3	13	Cursor On
DC4	14	Cursor Off
US	1F	Reset
ETX	03	Down Load Font
ENQ d1~d45 CR	05 d1~d45 0D	Message Scroll
SOH	01	Data to Peripheral
! # STX	21 23 02	Data to Display

## 5.6 ADM788 mode command list

Command	Code (hex)	Function Description
CLR	0C	Clear display
CR	0D	Carriage return
SLE1	0E	Clear up line and move cursor to upper line left most end
SLE2	0F	Clear low line and move cursor to lower line left most end
DC0 n	10 n	Set period to upper line last n position $31H \leq n \leq 44H$
DC1 n	11 n	Set line blanking , n = 31H up line n = 32H low line
DC2 n	12 n	Clear line blanking , n = 31H up line n = 32H low line
SF1	1E	Clear field 1 and move cursor to field 1 fast position
SF2	1F	Clear field 2 and move cursor to field 2 fast position

## 5.7 DSP-800 mode command list

Command	Code (hex)	Function Description
EOT SOH I n ETB	04 01 49 n 17	Select international character set.
EOT SOH P n ETB	04 01 50 n 17	Move cursor to specified position. $31H \leq n \leq 58H$
EOT SOH C n m ETB	04 01 43 n m 17	Clear display range from n position to m position and move cursor to n position. $31H \leq n \leq m \leq 58H$
EOT SOH S n ETB	04 01 53 n 17	Save the current displaying data to n layer for demo display. $31H \leq n \leq 33H$ Refer*1
EOT SOH D n m ETB	04 01 44 n m 17	Display the saved data $31H \leq n \leq 37H$ $31H \leq m \leq 37H$ Refer*2
EOT SOH A n ETB	04 01 41 n 17	Brightness adjustment. $31H \leq n \leq 34H$
EOT SOH F n ETB	04 01 46 n 17	Blink display screen. $0 \leq n \leq 255$
EOT SOH & n [px5] ETB	04 01 26 n p1...p5 17	Define download characters $20H < n \leq FFH$
EOT SOH ? n ETB	04 01 3F n 17	Delete download characters. $20H < n \leq FFH$
EOT SOH = n ETB	04 01 3D n 17	Select peripheral device. n = 31H,select printer n = 32H,select display
EOT SOH % ETB	04 01 25 17	Initialize display
EOT SOH @ ETB	04 01 40 17	Execute self-test



\*REMARK :

\*1 Using commands “EOT SOH S n ETB”, the value (Hex) of parameter.

n	Layer
31h	Save data in layer 1
32h	Save data in layer 2
33h	Save data in layer 3

\*2 Using commands “EOT SOH D n m ETB”, the value (Hex) of parameter.

WinPOS extended “select mode” from 33h to 37h

n	Select layer	m	Select mode
31h	Demo layer 1	31h	Demo mode 1
32h	Demo layer 2	32h	Demo mode 2
33h	Demo layer 3	33h	Demo mode 3
34h	Demo layer 1 + 2	34h	Demo mode 1 + 2
35h	Demo layer 1 + 3	35h	Demo mode 1 + 3
36h	Demo layer 2 + 3	36h	Demo mode 2 + 3
37h	Demo layer 1 + 2 + 3	37h	Demo mode 1 + 2 + 3

## 5.8 EPSON Esc / pos command list

Command	Code (hex)	Function Description
HT	09	Move cursor right.
BS	08	Move cursor left.
US LF	1FOA	Move cursor up.
LF	0A	Move cursor down.
US CR	1F 0D	Move cursor to right-most position.
CR	0D	Move cursor to left-most position.
HOM	0B	Move cursor to home position.
US B	1F 42	Move cursor to bottom position.
US \$ x y	1F 24 x y	Move cursor to specified position. $1 \leq x \leq 20$ $1 \leq y \leq 2$
CLR	0C	Clear display screen.
CAN	18	Clear cursor line
US X n	1F 58 n	Brightness adjustment. $1 \leq n \leq 4$
US E n	1F 45 n	Blink display screen. $0 \leq n \leq 255$
ESC @	1B 40	Initialize display.
ESC t n	1B 74 n	Select character code table. $0 \leq n \leq 7, 12, 16, 19, 40$ Refer*2
ESC R n	1B 52 n	Select international character set. $0 \leq n \leq 10$ Refer*1
US r n	1F 72 n	Select/cancel reverse character. $0 \leq n \leq 1$
US MD1	1F 01	Specify overwrite mode.
US MD2	1F 02	Specify vertical scroll mode.
US MD3	1F 03	Specify horizontal scroll mode.
ESC & s n m [a(p1..pa)]x m-n	1B 26 1 n m [a(p1..pa)]x m-n	Define download characters. $32 \leq n \leq 255$ $1 \leq a \leq 5$ p1..p5 =row1..row5
ESC ?	1B 3F n	Delete downloads characters. $32 \leq n \leq 255$

ESC %	1B 25 n	Select/cancel download character set. n = 0 , Cancel n = 1 , Select
ESC = n	1B 3D n	Select peripheral device. n bit 0 = 1 select printer n bit 1 = 1 select display
ESC & n s [p]	1B 26 n s data	Define user font pattern Refer *3
US :	1F3A	Set starting/ending position of macro definition.
US ^ n m	1F 5E n m	Execute and quit macro. $0 \leq n \leq 255$ , $0 \leq m \leq 255$
US @	1F 40	Execute self-test.
US T h m	1F 54 h m	Display time $0 \leq h \leq 23$ , $0 \leq m \leq 59$
US U	1F 55	Display time continuously
US C n	1F 43 n	Select / cancel cursor display n = 1 , cursor on n = 0 , cursor off
US .	1F 2E n	Display Period. $32 \leq n \leq 126$ and $128 \leq n \leq 255$
US ,	1F 2C n	Display Comma. $32 \leq n \leq 126$ and $128 \leq n \leq 255$
US ;	1F 3B n	Display Semicolon. $32 \leq n \leq 126$ and $128 \leq n \leq 255$

\*REMARK :

\*1 Select international character set

n	International font	n	International font
0	U.S.A.	8	Japan
1	France	9	Norway
2	Germany	10	Denmark II
3	U.K.	11	Slavonic
4	Denmark I	12	Russia
5	Sweden	13	Portuguese
6	Italy	14	Greek
7	Spain	15	Reserved

\*2 Select character code table

n	Code table	n	Code table
0	PC437,USA standard Euro	7	PC866, Russia
1	Katakana for Japan	12	PC737, Greek
2	PC850,Multilingual	13	PC775
3	PC860, Portuguese	14	PC864
4	PC863,Canadian-French	16	WPC1252
5	PC865,Nordic	19	PC858, Euro
6	PC852, Slavonic	26	WPC1257

## 6. CHARACTER SET

### 6.1 International Font

#### 6.1.1 USA, standard character set (20h – 7Fh)

	00	01	02	03	04	05	06	07	08	09	0A	0B	0C	0D	0E	0F
<b>20</b>	<u>SP</u> 0020	!	"	#	\$	%	&	'	(	)	*	+	,	-	.	/
<b>30</b>	0	1	2	3	4	5	6	7	8	9	:	;	<	=	>	?
<b>40</b>	@	A	B	C	D	E	F	G	H	I	J	K	L	M	N	O
<b>50</b>	P	Q	R	S	T	U	V	W	X	Y	Z	[	\	]	^	_
<b>60</b>	`	a	b	c	d	e	f	g	h	i	j	k	l	m	n	o
<b>70</b>	p	q	r	s	t	u	v	w	x	y	z	{		}	~	<u>DEL</u> 007F

## 6.1.2 Other character sets

U.S.A	#	\$	@	[	\	]	^	`	{		}	~
France	#	\$	à	°	ç	§	^	`	é	ù	è	¨
Germany	#	\$	§	Ä	Ö	Ü	^	`	ä	ö	ü	ß
U.K	£	\$	@	[	\	]	^	`	{		}	~
Denmark I	#	\$	@	Æ	Ø	Å	^	`	æ	ø	å	~
Sweden	#	¤	É	Ä	Ö	Å	Ü	é	ä	ö	å	ü
Italy	#	\$	@	°	\	é	^	ù	à	ò	è	ì
Spain	Pt	\$	@	í	Ñ	¿	^	`	¨	ñ	}	~
Japan	#	\$	@	[	¥	]	^	`	{		}	~
Norway	#	¤	É	Æ	Ø	Å	Ü	é	æ	ø	å	ü
Denmark II	#	\$	É	Æ	Ø	Å	Ü	é	æ	ø	å	ü
Slavonic	#	\$	@	[	\	]	^	`	{		}	~
Russia	#	\$	@	[	\	]	^	`	{		}	~

## 6.2 Code Page

### 6.2.1 PC437 : USA, Standard Europe (80H – FFH)

	00	01	02	03	04	05	06	07	08	09	0A	0B	0C	0D	0E	0F
<b>80</b>	Ç 00C7	ü 00FC	é 00E9	ã 00E2	ä 00E4	à 00E0	å 00E5	ç 00E7	ë 00EA	ë 00EB	è 00E8	ï 00EF	î 00EE	ì 00EC	Ä 00C4	Å 00C5
<b>90</b>	É 00C9	æ 00E6	Æ 00C6	ø 00F4	ö 00F6	ò 00F2	û 00FB	ù 00F9	ÿ 00FF	Ö 00D6	Ü 00DC	¢ 00A2	£ 00A3	¥ 00A5	€ 20A7	f 0192
<b>A0</b>	á 00E1	í 00ED	ó 00F3	ú 00FA	ñ 00F1	Ñ 00D1	ª 00AA	º 00BA	¿ 00BF	¬ 2310	¬ 00AC	½ 00BD	¾ 00BC	¡ 00A1	« 00AB	» 00BB
<b>B0</b>	▒ 2591	▓ 2592	█ 2593	 2502	┆ 2524	┆ 2561	┆ 2562	┆ 2556	┆ 2555	┆ 2563	 2551	┆ 2557	┆ 255D	┆ 255C	┆ 255B	┆ 2510
<b>C0</b>	┆ 2514	┆ 2534	┆ 252C	┆ 251C	┆ 2500	┆ 253C	┆ 255E	┆ 255F	┆ 255A	┆ 2554	┆ 2569	┆ 2566	┆ 2560	= 2550	┆ 256C	┆ 2567
<b>D0</b>	┆ 2568	┆ 2564	┆ 2565	┆ 2559	┆ 2558	┆ 2552	┆ 2553	┆ 256B	┆ 256A	┆ 2518	┆ 250C	█ 2588	█ 2584	█ 258C	█ 2590	█ 2580
<b>E0</b>	α 03B1	ß 00DF	Γ 0393	Π 03C0	Σ 03A3	σ 03C3	μ 00B5	τ 03C4	Φ 03A6	Θ 0398	Ω 03A9	δ 03B4	∞ 221E	φ 03C6	ε 03B5	∏ 2229
<b>F0</b>	≡ 2261	± 00B1	≥ 2265	≤ 2264	∫ 2320	∫ 2321	÷ 00F7	≈ 2248	° 00B0	· 2219	· 00B7	√ 221A	² 207F	² 00B2	█ 25A0	<u>NBSP</u> 00A0

### 6.2.2 Katakana (80H – FFH)

	00	01	02	03	04	05	06	07	08	09	0A	0B	0C	0D	0E	0F
<b>80</b>	- 2500	- 2501	█ 2502	█ 2503	█ 2504	█ 2505	- 2506	█ 2507	█ 2508	█ 2509	█ 250A	█ 250B	 250C	 250D	 250E	 250F
<b>90</b>	 2510	 2511	 2512	 2513	█ 2588	█ 2592	▒ 2591	→ 2192	← 2190	↑ 2191	↓ 2193	× 00D7	÷ 00F7	± 00B1	≤ 2266	≥ 2267
<b>A0</b>	▒ FF60	。 FF61	「 FF62	」 FF63	、 FF64	・ FF65	ヲ FF66	ア FF67	イ FF68	ウ FF69	エ FF6A	オ FF6B	ヤ FF6C	ユ FF6D	ヨ FF6E	ツ FF6F
<b>B0</b>	- FF70	ア FF71	イ FF72	ウ FF73	エ FF74	オ FF75	カ FF76	キ FF77	ク FF78	ケ FF79	コ FF7A	サ FF7B	シ FF7C	ス FF7D	セ FF7E	ソ FF7F
<b>C0</b>	タ FF80	チ FF81	ツ FF82	テ FF83	ト FF84	ナ FF85	ニ FF86	ヌ FF87	ネ FF88	ノ FF89	ハ FF8A	ヒ FF8B	フ FF8C	ヘ FF8D	ホ FF8E	マ FF8F
<b>D0</b>	ミ FF90	ム FF91	メ FF92	モ FF93	ヤ FF94	ユ FF95	ヨ FF96	ラ FF97	リ FF98	ル FF99	レ FF9A	ロ FF9B	ワ FF9C	ン FF9D	ノ FF9E	° FF9F
<b>E0</b>	□ 25A1	█ 25A0	█ 2500	○ 25CB	● 25CF	◇ 25C7	◆ 25C6	+2500	▶ 2500	◀ 2500	▲ 2500	▼ 2500	◀ 226A	▶ 226B	½ 00BD	¾ 00BC
<b>F0</b>	日 3012	月 3012	火 3012	水 3012	木 3012	金 3012	土 3012	年 3012	円 3012	分 3012	人 3012	大 3012	中 3012	小 3012	° 3012	° 2103

### 6.2.3 PC850 : Multilingual (80H – FFH)

	00	01	02	03	04	05	06	07	08	09	0A	0B	0C	0D	0E	0F
<b>80</b>	Ç 00C7	ü 00FC	é 00E9	â 00E2	ä 00E4	à 00E0	å 00E5	ç 00E7	ë 00EA	è 00EB	è 00E8	ï 00EF	î 00EE	ì 00EC	Ä 00C4	Å 00C5
<b>90</b>	É 00C9	æ 00E6	Æ 00C6	ø 00F4	ö 00F6	ò 00F2	û 00FB	ù 00F9	ÿ 00FF	Ö 00D6	Û 00DC	ø 00F8	£ 00A3	∅ 00D8	× 00D7	f 0192
<b>A0</b>	á 00E1	í 00ED	ó 00F3	ú 00FA	ñ 00F1	Ñ 00D1	ª 00AA	º 00BA	¿ 00BF	® 00AE	¬ 00AC	½ 00BD	¼ 00BC	¡ 00A1	« 00AB	» 00BB
<b>B0</b>	▒ 2591	▒ 2592	▒ 2593	 2502	 2524	Á 00C1	Ã 00C2	À 00C0	© 00A9	¶ 2563	 2551	¶ 2557	¶ 255D	¢ 00A2	¥ 00A5	⌋ 2510
<b>C0</b>	⌋ 2514	⌋ 2534	⌋ 252C	 251C	— 2500	† 253C	ã 00E3	Ã 00C3	⌋ 255A	¶ 2554	⌋ 2569	¶ 2566	¶ 2560	= 2550	¶ 256C	∗ 00A4
<b>D0</b>	ø 00F0	Ð 00D0	Ê 00CA	Ë 00CB	È 00C8	ı 0131	Í 00CD	Î 00CE	Ï 00CF	⌋ 2518	⌋ 250C	■ 2588	■ 2584	 00A6	ì 00CC	■ 2580
<b>E0</b>	Ó 00D3	ß 00DF	Õ 00D4	Ò 00D2	õ 00F5	Õ 00D5	µ 00B5	þ 00FE	ƒ 00DE	Ú 00DA	Û 00DB	Ù 00D9	Ý 00FD	Ý 00DD	— 00AF	´ 00B4
<b>F0</b>	- 00AD	± 00B1	= 2017	¾ 00BE	¶ 00B6	§ 00A7	÷ 00F7	˘ 00B8	° 00B0	¨ 00A8	· 00B7	± 00B9	§ 00B3	² 00B2	■ 25A0	<u>NBSP</u> 00A0

### 6.2.4 PC860 : Portuguese (80H – FFH)

	00	01	02	03	04	05	06	07	08	09	0A	0B	0C	0D	0E	0F
<b>80</b>	Ç 00C7	ü 00FC	é 00E9	â 00E2	ã 00E3	à 00E0	Á 00C1	ç 00E7	ê 00EA	Ê 00CA	è 00E8	Í 00CD	Ô 00D4	ì 00EC	Ã 00C3	Â 00C2
<b>90</b>	É 00C9	À 00C0	È 00C8	ô 00F4	õ 00F5	ò 00F2	Ú 00DA	ù 00F9	Ì 00CC	Õ 00D5	Û 00DC	ç 00A2	£ 00A3	Ù 00D9	Ps 20A7	Ó 00D3
<b>A0</b>	á 00E1	í 00ED	ó 00F3	ú 00FA	ñ 00F1	Ñ 00D1	ª 00AA	º 00BA	¿ 00BF	Ò 00D2	¬ 00AC	½ 00BD	¼ 00BC	¡ 00A1	« 00AB	» 00BB
<b>B0</b>	▒ 2591	▒ 2592	▒ 2593	 2502	 2524	≠ 2561	≠ 2562	¶ 2556	≠ 2555	≠ 2563	 2551	¶ 2557	¶ 255D	¶ 255C	≠ 255B	⌋ 2510
<b>C0</b>	⌋ 2514	⌋ 2534	⌋ 252C	 251C	— 2500	† 253C	¶ 255E	¶ 255F	⌋ 255A	¶ 2554	⌋ 2569	¶ 2566	¶ 2560	= 2550	¶ 256C	≠ 2567
<b>D0</b>	⌋ 2568	¶ 2564	¶ 2565	⌋ 2559	⌋ 2558	¶ 2552	¶ 2553	≠ 256B	≠ 256A	⌋ 2518	⌋ 250C	■ 2588	■ 2584	■ 258C	■ 2590	■ 2580
<b>E0</b>	α 03B1	β 00DF	Γ 0393	π 03C0	Σ 03A3	σ 03C3	μ 03BC	τ 03C4	Φ 03A6	Θ 0398	Ω 03A9	δ 03B4	∞ 221E	φ 03C6	ε 03B5	∩ 2229
<b>F0</b>	≡ 2261	± 00B1	≥ 2265	≤ 2264	∫ 2320	J 2321	÷ 00F7	≈ 2248	° 00B0	· 2219	· 00B7	√ 221A	ⁿ 207F	² 00B2	■ 25A0	00A0



### 6.2.5 PC863 : Canadian-French (80H – FFH)

	00	01	02	03	04	05	06	07	08	09	0A	0B	0C	0D	0E	0F
80	Ç 00C7	ü 00FC	é 00E9	â 00E2	Â 00C2	à 00E0	¶ 00B6	ç 00E7	ê 00EA	ë 00EB	è 00E8	ï 00EF	î 00EE	 2017	À 00C0	§ 00A7
90	É 00C9	È 00C8	Ê 00CA	ô 00F4	Ë 00CB	Ï 00CF	û 00FB	ù 00F9	¤ 00A4	Ô 00D4	Û 00DC	¢ 00A2	£ 00A3	Ù 00D9	Û 00DB	f 0192
A0	¡ 00A6	´ 00B4	ó 00F3	ú 00FA	¨ 00A8	¸ 00B8	³ 00B3	- 00AF	Î 00CE	┌ 2310	┐ 00AC	½ 00BD	¼ 00BC	¾ 00BE	« 00A8	» 00BB
B0				 2502	├ 2524	≡ 2561	≡ 2562	≡ 2556	≡ 2555	≡ 2563	≡ 2551	≡ 2557	≡ 255D	≡ 255C	≡ 255B	└ 2510
C0	┌ 2514	┐ 2534	└ 252C	├ 251C	— 2500	├ 253C	≡ 255E	≡ 255F	≡ 255A	≡ 2554	≡ 2569	≡ 2566	≡ 2560	≡ 2550	≡ 256C	≡ 2567
D0	≡ 2568	≡ 2564	≡ 2565	≡ 2559	≡ 2558	≡ 2552	≡ 2553	≡ 256B	≡ 256A	└ 2518	┌ 250C	■ 2588	■ 2584	■ 258C	■ 2590	■ 2580
E0	α 03B1	β 00DF	Γ 0393	π 03C0	Σ 03A3	σ 03C3	μ 03BC	τ 03C4	Φ 03A6	Θ 0398	Ω 03A9	δ 03B4	∞ 221E	φ 03C6	ε 03B5	∩ 2229
F0	≡ 2261	± 00B1	≥ 2265	≤ 2264	∫ 2320	J 2321	÷ 00F7	≈ 2248	° 00B0	• 2219	· 00B7	√ 221A	² 207F	² 00B2	■ 25A0	00A0

### 6.2.6 PC865 : Nordic (80H – FFH)

	00	01	02	03	04	05	06	07	08	09	0A	0B	0C	0D	0E	0F
80	Ç 00C7	ü 00FC	é 00E9	â 00E2	ä 00E4	à 00E0	å 00E5	ç 00E7	ê 00EA	ë 00EB	è 00E8	ï 00EF	î 00EE	ì 00EC	Ä 00C4	Å 00C5
90	É 00C9	æ 00E6	Æ 00C6	ô 00F4	ö 00F6	ò 00F2	û 00FB	ù 00F9	ÿ 00FF	Ö 00D6	Ü 00DC	ø 00F8	£ 00A3	Ø 00D8	Ps 20A7	f 0192
A0	á 00E1	í 00ED	ó 00F3	ú 00FA	ñ 00F1	Ñ 00D1	 00AA	 00BA	¿ 00BF	┌ 2310	┐ 00AC	½ 00BD	¼ 00BC	¾ 00BE	« 00A8	» 00AB
B0				 2502	├ 2524	≡ 2561	≡ 2562	≡ 2556	≡ 2555	≡ 2563	≡ 2551	≡ 2557	≡ 255D	≡ 255C	≡ 255B	└ 2510
C0	┌ 2514	┐ 2534	└ 252C	├ 251C	— 2500	├ 253C	≡ 255E	≡ 255F	≡ 255A	≡ 2554	≡ 2569	≡ 2566	≡ 2560	≡ 2550	≡ 256C	≡ 2567
D0	≡ 2568	≡ 2564	≡ 2565	≡ 2559	≡ 2558	≡ 2552	≡ 2553	≡ 256B	≡ 256A	└ 2518	┌ 250C	■ 2588	■ 2584	■ 258C	■ 2590	■ 2580
E0	α 03B1	β 00DF	Γ 0393	π 03C0	Σ 03A3	σ 03C3	μ 03BC	τ 03C4	Φ 03A6	Θ 0398	Ω 03A9	δ 03B4	∞ 221E	φ 03C6	ε 03B5	∩ 2229
F0	≡ 2261	± 00B1	≥ 2265	≤ 2264	∫ 2320	J 2321	÷ 00F7	≈ 2248	° 00B0	• 2219	· 00B7	√ 221A	² 207F	² 00B2	■ 25A0	00A0

## 6.2.7 PC852 : Slavonic (80H – FFH)

	00	01	02	03	04	05	06	07	08	09	0A	0B	0C	0D	0E	0F
<b>80</b>	Ї 00C7	Û 00FC	É 00E9	Ā 00E2	Ä 00E4	Ů 016F	Ć 0107	Ç 00E7	Ł 0142	È 00EB	Ö 0150	Ó 0151	İ 00EE	Ž 0179	Ä 00C4	Ć 0106
<b>90</b>	É 00C9	Í 0139	Í 013A	Ô 00F4	Ö 00F6	Ł 013D	İ 013E	Š 015A	Ś 015B	Ö 00D6	Û 00DC	Ť 0164	Ŧ 0165	Ł 0141	× 00D7	Č 010D
<b>A0</b>	á 00E1	í 00ED	ó 00F3	ú 00FA	Ą 0104	ą 0105	Ż 017D	ż 017E	Ę 0118	ę 0119	¬ 00AC	ž 017A	č 010C	š 015F	« 00AB	» 00BB
<b>B0</b>	▨ 2591	▩ 2592	▪ 2593	 2502	┆ 2524	Á 00C1	Ă 00C2	Ë 011A	Ş 015E	ǂ 2563	ǃ 2551	Ǆ 2557	ǅ 255D	Ž 017B	Ż 017C	Ǉ 2510
<b>C0</b>	Ł 2514	ł 2534	Ť 252C	Ŧ 251C	— 2500	† 253C	Ǻ 0102	ǻ 0103	Ł 255A	ǂ 2554	ǃ 2569	Ǆ 2566	ǅ 2560	= 2550	Ǉ 256C	* 00A4
<b>D0</b>	đ 0111	Đ 0110	Ǿ 010E	Ë 00CB	đ 010F	Ń 0147	Í 00CD	İ 00CE	ě 011B	ǂ 2518	ǂ 250C	▀ 2588	▀ 2584	Ŧ 0162	Ů 016E	▀ 2580
<b>E0</b>	Ó 00D3	ß 00DF	Ö 00D4	Ń 0143	ń 0144	ň 0148	š 0160	ś 0161	Ŕ 0154	Ú 00DA	ř 0155	Ů 0170	ý 00FD	Ý 00DD	Ŧ 0163	´ 00B4
<b>F0</b>	- 00AD	~ 02DD	˘ 02DB	˘ 02C7	˘ 02D8	Š 00A7	÷ 00F7	˘ 00B8	˘ 00E0	˘ 00A8	˘ 02D9	ú 0171	ř 0158	ř 0159	▀ 25A0	<u>NBSP</u> 00A0

## 6.2.8 PC866 : Russia (80H – FFH)

	00	01	02	03	04	05	06	07	08	09	0A	0B	0C	0D	0E	0F
<b>80</b>	А 0410	Б 0411	В 0412	Г 0413	Д 0414	Е 0415	Ж 0416	З 0417	И 0418	Й 0419	К 041A	Л 041B	М 041C	Н 041D	О 041E	П 041F
<b>90</b>	Р 0420	С 0421	Т 0422	У 0423	Ф 0424	Х 0425	Ц 0426	Ч 0427	Ш 0428	Щ 0429	Ъ 042A	Ы 042B	Ь 042C	Э 042D	Ю 042E	Я 042F
<b>A0</b>	а 0430	б 0431	в 0432	г 0433	д 0434	е 0435	ж 0436	з 0437	и 0438	й 0439	к 043A	л 043B	м 043C	н 043D	о 043E	п 043F
<b>B0</b>	▨ 2591	▩ 2592	▪ 2593	 2502	┆ 2524	ǂ 2561	ǃ 2562	Ǆ 2556	ǅ 2555	ǆ 2563	Ǉ 2551	ǈ 2557	ǉ 255D	Ǌ 255C	ǋ 255B	ǌ 2510
<b>C0</b>	Ł 2514	ł 2534	Ť 252C	Ŧ 251C	— 2500	† 253C	ǂ 255E	ǃ 255F	Ł 255A	ǂ 2554	ǃ 2569	Ǆ 2566	ǅ 2560	= 2550	Ǉ 256C	ǈ 2567
<b>D0</b>	ǂ 2568	ǃ 2564	Ǆ 2565	ǅ 2559	ǆ 2558	Ǉ 2552	ǈ 2553	ǉ 256B	Ǌ 256A	ǋ 2518	ǌ 250C	▀ 2588	▀ 2584	▀ 258C	▀ 2590	▀ 2580
<b>E0</b>	р 0440	с 0441	т 0442	у 0443	ф 0444	х 0445	ц 0446	ч 0447	ш 0448	щ 0449	ъ 044A	ы 044B	ь 044C	э 044D	ю 044E	я 044F
<b>F0</b>	È 0401	è 0451	É 0404	e 0454	Ï 0407	ï 0457	ÿ 040E	ÿ 045E	˘ 00B0	˘ 2219	˘ 00B7	˘ 221A	№ 2116	* 00A4	▀ 25A0	<u>NBSP</u> 00A0

## 6.2.9 PC858 : Euro (80H – FFH)

	00	01	02	03	04	05	06	07	08	09	0A	0B	0C	0D	0E	0F
<b>80</b>	Ç 00C7	ù 00FC	é 00E9	ã 00E2	ä 00E4	à 00E0	å 00E5	ç 00E7	ë 00EA	è 00EB	è 00E8	ï 00EF	î 00EE	ì 00EC	Ä 00C4	Å 00C5
<b>90</b>	É 00C9	æ 00E6	Æ 00C6	ø 00F4	ö 00F6	ò 00F2	û 00FB	ù 00F9	ÿ 00FF	Ö 00D6	Û 00DC	ø 00F8	£ 00A3	∅ 00D8	× 00D7	f 0192
<b>A0</b>	á 00E1	í 00ED	ó 00F3	ú 00FA	ñ 00F1	Ñ 00D1	ª 00AA	º 00BA	¿ 00BF	® 00AE	¬ 00AC	½ 00BD	¼ 00BC	¡ 00A1	« 00AB	» 00BB
<b>B0</b>	▒ 2591	▓ 2592	█ 2593	 2502	└ 2524	Á 00C1	Ã 00C2	À 00C0	© 00A9	¶ 2563	∥ 2551	⌋ 2557	⌌ 255D	¢ 00A2	¥ 00A5	⌋ 2510
<b>C0</b>	⌌ 2514	⌍ 2534	⌎ 252C	⌏ 251C	— 2500	† 253C	ã 00E3	Ä 00C3	⌐ 255A	⌑ 2554	⌒ 2569	⌓ 2566	⌔ 2560	= 2550	⌕ 256C	* 00A4
<b>D0</b>	ø 00F0	Ð 00D0	Ê 00CA	Ë 00CB	È 00C8	€ 20AC	Í 00CD	Î 00CE	Ï 00CF	⌑ 2518	⌒ 250C	■ 2588	■ 2584	¡ 00A6	ì 00CC	■ 2580
<b>E0</b>	Ó 00D3	ß 00DF	Õ 00D4	Ò 00D2	ö 00F5	Õ 00D5	µ 00B5	þ 00FE	ƒ 00DE	Ú 00DA	Û 00DB	Ü 00D9	Ý 00FD	Ý 00DD	— 00AF	´ 00B4
<b>F0</b>	- 00AD	± 00B1	= 2017	¾ 00BE	¶ 00B6	§ 00A7	÷ 00F7	¸ 00B8	° 00B0	¨ 00A8	· 00B7	± 00B9	³ 00B3	² 00B2	■ 25A0	<u>NBSP</u> 00A0

## 6.2.10 WPC1252 (80H – FFH)

	00	01	02	03	04	05	06	07	08	09	0A	0B	0C	0D	0E	0F
<b>80</b>	€ 20AC	▒ 2591	¸ 201A	f 0192	# 201E	... 2026	† 2020	‡ 2C21	ˆ 02C6	% 2030	Š 0160	< 2039	Œ 0152	▒ 2591	Ž 017D	▒ 2591
<b>90</b>	▒ 2591	\ 2018	/ 2019	“ 201C	” 201D	• 2022	— 2013	— 2C14	˜ 02DC	™ 2122	Š 0161	> 203A	œ 0153	▒ 2591	Ž 017E	Ÿ 0178
<b>A0</b>	<u>NBSP</u> 00A0	¡ 00A1	¢ 00A2	£ 00A3	* 00A4	¥ 00A5	¦ 00A6	§ 00A7	¨ 00A8	© 00A9	ª 00AA	« 00AB	¬ 00AC	— 00AD	® 00AE	¯ 00AF
<b>B0</b>	° 00B0	± 00B1	² 00B2	³ 00B3	´ 00B4	µ 00B5	¶ 00B6	· 00B7	¸ 00B8	¹ 00B9	º 00BA	» 00BB	¼ 00BC	½ 00BD	¾ 00BE	¿ 00BF
<b>C0</b>	À 00C0	Á 00C1	Ã 00C2	Ä 00C3	Å 00C4	Ä 00C5	Æ 00C6	Ç 00C7	È 00C8	É 00C9	Ê 00CA	Ë 00CB	Ì 00CC	Í 00CD	Î 00CE	Ï 00CF
<b>D0</b>	Ð 00D0	Ñ 00D1	Ò 00D2	Ó 00D3	Ô 00D4	Õ 00D5	Ö 00D6	× 00D7	Ø 00D8	Ù 00D9	Ú 00DA	Û 00DB	Ü 00DC	Ý 00DD	Þ 00DE	ß 00DF
<b>E0</b>	à 00E0	á 00E1	ã 00E2	ä 00E3	å 00E4	ä 00E5	æ 00E6	ç 00E7	è 00E8	é 00E9	ê 00EA	ë 00EB	ì 00EC	í 00ED	î 00EE	ï 00EF
<b>F0</b>	ø 00F0	ñ 00F1	ò 00F2	ó 00F3	ô 00F4	õ 00F5	ö 00F6	÷ 00F7	ø 00F8	ù 00F9	ú 00FA	û 00FB	ü 00FC	ý 00FD	þ 00FE	ÿ 00FF

### 6.2.11 PC737 : Greek (80H – FFH)

	00	01	02	03	04	05	06	07	08	09	0A	0B	0C	0D	0E	0F
<b>80</b>	Α 0391	Β 0392	Γ 0393	Δ 0394	Ε 0395	Ζ 0396	Η 0397	Θ 0398	Ι 0399	Κ 039A	Λ 039B	Μ 039C	Ν 039D	Ξ 039E	Ο 039F	Π 03A0
<b>90</b>	Ρ 03A1	Σ 03A3	Τ 03A4	Υ 03A5	Φ 03A6	Χ 03A7	Ψ 03A8	Ω 03A9	α 03B1	β 03B2	γ 03B3	δ 03B4	ε 03B5	ζ 03B6	η 03B7	θ 03B8
<b>A0</b>	ι 03B9	κ 03BA	λ 03BB	μ 03BC	ν 03BD	ξ 03BE	ο 03BF	π 03C0	ρ 03C1	σ 03C3	ς 03C2	τ 03C4	υ 03C5	φ 03C6	χ 03C7	ψ 03C8
<b>B0</b>	⋮ 2591	⋮ 2592	⋮ 2593	 2502	 2524	 2561	 2562	 2556	 2555	 2563	 2551	 2557	 255D	 255C	 255B	 2510
<b>C0</b>	⌒ 2514	⌒ 2534	⌒ 252C	⌒ 251C	— 2500	⌒ 253C	⌒ 255E	⌒ 255F	⌒ 255A	⌒ 2554	⌒ 2569	⌒ 2566	⌒ 2560	= 2550	⌒ 256C	⌒ 2567
<b>D0</b>	⌒ 2568	⌒ 2564	⌒ 2565	⌒ 2559	⌒ 2558	⌒ 2552	⌒ 2553	⌒ 253B	⌒ 256A	⌒ 2518	⌒ 250C	■ 2588	■ 2584	■ 258C	■ 2590	■ 2580
<b>E0</b>	ω 03C9	ό 03AC	έ 03AD	ή 03AE	ϊ 03CA	ί 03AF	ό 03CC	ύ 03CD	ϋ 03CB	ώ 03CE	Α 0386	Ε 0388	Η 0389	Ι 038A	Ο 038C	Υ 038E
<b>F0</b>	Ω 038F	± 00B1	≥ 2265	≤ 2264	İ 03AA	ÿ 03AB	÷ 00F7	≈ 2248	· 2219	£ 00A3	· 00B7	√ 221A	² 207F	² 00B2	■ 25A0	<u>NBSP</u> 00A0

### 6.2.12 WPC1257 (80H – FFH)

	00	01	02	03	04	05	06	07	08	09	0A	0B	0C	0D	0E	0F	
<b>80</b>	€ 20AC	⋮ 2018	⋮ 201A	⋮ 201E	⋮ 201E	⋮ 2026	† 2020	‡ 2C21	⋮ 2030	‰ 2030	⋮ 2039	< 2039	⋮ 203A	⋮ 203A	∞ 00A8	∞ 02C7	∞ 00B8
<b>90</b>	⋮ 2018	⋮ 2019	⋮ 201C	⋮ 201D	⋮ 2022	⋮ 2013	— 2013	— 2C14	⋮ 2122	⋮ 2122	⋮ 203A	> 203A	⋮ 203A	— 00AF	∞ 02DB	⋮ 203A	
<b>A0</b>	<u>NBSP</u> 00A0	⋮ 00A2	ϕ 00A2	£ 00A3	* 00A4	⋮ 00A6	ι 00A6	§ 00A7	∅ 00D8	@ 00A9	℞ 0156	« 00AB	¬ 00AC	— 00AD	@ 00AE	Æ 00C6	
<b>B0</b>	° 00B0	± 00B1	² 00B2	³ 00B3	⁄ 00B4	μ 00B5	¶ 00B6	· 00B7	∅ 00F8	± 00B9	℞ 0157	» 00BB	¼ 00BC	½ 00BD	¾ 00BE	æ 00E6	
<b>C0</b>	Ä 0104	ı 012E	Ā 0100	Ć 0106	Ä 00C4	Å 00C5	Ě 0118	Ë 0112	Č 010C	É 00C9	Ž 0179	Ê 0116	Ĝ 0122	Ķ 0136	Ī 012A	Ĭ 013B	
<b>D0</b>	Š 0160	Ň 0143	Ň 0145	Ó 00D3	Ō 014C	Ŏ 00D5	Ö 00D6	× 00D7	Ů 0172	Ł 0141	Ś 015A	Ū 016A	Û 00DC	Ž 017B	Ž 017D	ß 00DF	
<b>E0</b>	ą 0105	ı 012F	ā 0101	ć 0107	ä 00E4	å 00E5	ě 0119	ë 0113	č 010D	é 00E9	ž 017A	ê 0117	ĝ 0123	ķ 0137	ī 012B	ĭ 013C	
<b>F0</b>	š 0161	ň 0144	ň 0146	ó 00F3	ō 014D	ö 00F5	ö 00F6	÷ 00F7	ů 0173	ł 0142	ś 015B	ū 016B	û 00FC	ž 017C	ž 017E	· 02D9	

### 6.2.13 PC862 (80H – FFH)

	00	01	02	03	04	05	06	07	08	09	0A	0B	0C	0D	0E	0F
<b>80</b>	Ɔ 05D0	Ɱ 05D1	Ɱ 05D2	Ɔ 05D3	Ɱ 05D4	Ɔ 05D5	Ɱ 05D6	Ɔ 05D7	Ɱ 05D8	Ɔ 05D9	Ɱ 05DA	Ɔ 05DB	Ɱ 05DC	Ɔ 05DD	Ɱ 05DE	Ɔ 05DF
<b>90</b>	Ɱ 05E0	Ɔ 05E1	Ɱ 05E2	Ɔ 05E3	Ɱ 05E4	Ɔ 05E5	Ɱ 05E6	Ɔ 05E7	Ɱ 05E8	Ɔ 05E9	Ɱ 05EA	Ɔ 00A2	Ɱ 00A3	Ɱ 00A5	Ɱ 20A7	Ɔ 0192
<b>A0</b>	á 00E1	í 00ED	ó 00F3	ú 00FA	ñ 00F1	Ñ 00D1	ª 00AA	º 00BA	¿ 00BF	Ɔ 2310	Ɔ 00AC	Ɔ 00BD	Ɔ 00BC	¡ 00A1	« 00AB	» 00BB
<b>B0</b>	Ɱ 2591	Ɱ 2592	Ɱ 2593	Ɔ 2502	Ɔ 2524	Ɔ 2561	Ɔ 2562	Ɔ 2556	Ɔ 2555	Ɔ 2563	Ɔ 2551	Ɔ 2557	Ɔ 255D	Ɔ 255C	Ɔ 255B	Ɔ 2510
<b>C0</b>	Ɔ 2514	Ɔ 2534	Ɔ 252C	Ɔ 251C	Ɔ 2500	Ɔ 253C	Ɔ 255E	Ɔ 255F	Ɔ 255A	Ɔ 2554	Ɔ 2569	Ɔ 2566	Ɔ 2560	Ɔ 2550	Ɔ 256C	Ɔ 2567
<b>D0</b>	Ɔ 2568	Ɔ 2564	Ɔ 2565	Ɔ 2559	Ɔ 2558	Ɔ 2552	Ɔ 2553	Ɔ 253B	Ɔ 256A	Ɔ 2518	Ɔ 250C	⬛ 2588	⬛ 2584	⬛ 258C	⬛ 2590	⬛ 2580
<b>E0</b>	α 03B1	β 00DF	Γ 0393	Π 03C0	Σ 03A3	σ 03C3	μ 00B5	τ 03D4	Φ 03A6	Θ 0398	Ω 03A9	δ 03B4	∞ 221E	φ 03C6	ε 03B5	Π 2229
<b>F0</b>	≡ 2261	± 00B1	≥ 2265	≤ 2264	∫ 2320	∫ 2321	÷ 00F7	≈ 2248	° 00B0	· 2219	· 00B7	√ 221A	² 207F	² 00B2	■ 25A0	<u>NBSP</u> 00A0

### 6.2.14 WPC1250 (80H – FFH)

	00	01	02	03	04	05	06	07	08	09	0A	0B	0C	0D	0E	0F
<b>80</b>	€ 20AC	Ɱ	Ɔ 201A	Ɱ	“ 201E	… 2026	† 2020	‡ 2C21	Ɱ	‰ 2030	š 0160	< 2039	š 015A	ť 0164	ž 017D	ž 0179
<b>90</b>	Ɱ	˘ 2018	˘ 2019	“ 201C	” 201D	• 2022	– 2013	– 2C14	Ɱ	™ 2122	š 0161	> 203A	š 015B	ť 0165	ž 017E	ž 017A
<b>A0</b>	<u>NBSP</u> 00A0	˘ 02C7	˘ 02D8	£ 0141	* 00A4	À 0104	¡ 00A6	§ 00A7	“ 00A8	© 00A9	§ 015E	« 00AB	– 00AC	– 00AD	® 00AE	Ž 017B
<b>B0</b>	° 00B0	± 00B1	˘ 02DB	‡ 0142	˘ 00B4	μ 00B5	¶ 00B6	· 00B7	˘ 00B8	ą 0105	§ 015F	» 00BB	Ł 013D	“ 02DD	Ł 013E	ž 017C
<b>C0</b>	Ř 0154	Á 00C1	Ä 00C2	Ä 0102	Ä 00C4	Í 0139	Ć 0106	Ç 00C7	Č 010C	É 00C9	Ę 0118	Ě 00CB	Ě 011A	Í 00CD	Î 00CE	Ď 010E
<b>D0</b>	Đ 0110	Ň 0143	Ň 0147	Ó 00D3	Õ 00D4	Ö 0150	Ö 00D6	× 00D7	Ř 0158	Ů 016E	Ú 00DA	Ú 0170	Û 00DC	Ý 00DD	Ť 0162	ß 00DF
<b>E0</b>	ř 0155	á 00E1	ä 00E2	ä 0103	ä 00E4	í 013A	ć 0107	ç 00E7	č 010D	é 00E9	ę 0119	ě 00EB	ě 011B	í 00ED	î 00EE	ď 010F
<b>F0</b>	đ 0111	ň 0144	ň 0148	ó 00F3	õ 00F4	ö 0151	ö 00F6	÷ 00F7	ř 0159	ů 016F	ú 00FA	ú 0171	û 00FC	ý 00FD	ť 0163	· 02D9

## 6.2.15 WPC1251 (80H – FFH)

	00	01	02	03	04	05	06	07	08	09	0A	0B	0C	0D	0E	0F
<b>80</b>	Ѓ 0402	Ѓ 0403	ƒ 201A	ƒ 0453	„ 201E	… 2026	† 2020	‡ 2C21	€ 20AC	‰ 2030	Љ 0409	< 2039	Њ 040A	Ѓ 040C	Ѓ 040B	Ц 040F
<b>90</b>	Ѓ 0452	ˆ 2018	ˆ 2019	ˆ 201C	ˆ 201D	• 2022	– 2013	– 2C14	™ 2122	Љ 0459	> 203A	Њ 045A	Ѓ 045C	Ѓ 045B	Ц 045F	
<b>A0</b>	<u>NBSP</u> 00A0	Ÿ 040E	Ÿ 045E	Ј 0408	* 00A4	Г 0490	 00A6	§ 00A7	Ё 0401	© 00A9	€ 0404	« 00AB	¬ 00AC	– 00AD	® 00AE	İ 0407
<b>B0</b>	° 00B0	± 00B1	І 0406	і 0456	Г 0491	μ 00B5	¶ 00B6	· 00B7	ë 0451	№ 2116	е 0454	» 00BB	ј 0458	š 0405	š 0455	ı 0457
<b>C0</b>	А 0410	В 0411	В 0412	Г 0413	Д 0414	Е 0415	Ж 0416	З 0417	И 0418	Й 0419	К 041A	Л 041B	М 041C	Н 041D	О 041E	П 041F
<b>D0</b>	Р 0420	С 0421	Т 0422	У 0423	Ф 0424	Х 0425	Ц 0426	Ч 0427	Ш 0428	Щ 0429	Ъ 042A	Ы 042B	Ь 042C	Э 042D	Ю 042E	Я 042F
<b>E0</b>	а 0430	б 0431	в 0432	г 0433	д 0434	е 0435	ж 0436	з 0437	и 0438	й 0439	к 043A	л 043B	м 043C	н 043D	о 043E	п 043F
<b>F0</b>	р 0440	с 0441	т 0442	у 0443	ф 0444	х 0445	ц 0446	ч 0447	ш 0448	щ 0449	ъ 044A	ы 044B	ь 044C	э 044D	ю 044E	я 044F

## 6.2.16 WPC1253 (80H – FFH)

	00	01	02	03	04	05	06	07	08	09	0A	0B	0C	0D	0E	0F
<b>80</b>	€ 20AC	™ 2122	ƒ 201A	f 0192	„ 201E	… 2026	† 2020	‡ 2C21	™ 2122	‰ 2030	™ 2122	< 2039	™ 2122	™ 2122	™ 2122	™ 2122
<b>90</b>	™ 2122	ˆ 2018	ˆ 2019	ˆ 201C	ˆ 201D	• 2022	– 2013	– 2C14	™ 2122	™ 2122	> 203A	™ 2122	™ 2122	™ 2122	™ 2122	™ 2122
<b>A0</b>	<u>NBSP</u> 00A0	ˆ 0385	ˆ 0386	£ 00A3	* 00A4	¥ 00A5	 00A6	§ 00A7	™ 00A8	© 00A9	™ 00AA	« 00AB	¬ 00AC	– 00AD	® 00AE	– 2015
<b>B0</b>	° 00B0	± 00B1	² 00B2	³ 00B3	´ 0384	μ 00B5	¶ 00B6	· 00B7	‘E 0388	‘H 0389	‘I 038A	» 00BB	○ 038C	¼ 00BD	‘Y 038E	Ω 038F
<b>C0</b>	í 0390	А 0391	В 0392	Г 0393	Δ 0394	Е 0395	Ζ 0396	Η 0397	Θ 0398	Ι 0399	Κ 039A	Λ 039B	Μ 039C	Ν 039D	Ξ 039E	Ο 039F
<b>D0</b>	Π 03A0	Ρ 03A1	™ 03A2	Σ 03A3	Τ 03A4	Υ 03A5	Φ 03A6	Χ 03A7	Ψ 03A8	Ω 03A9	İ 03AA	ÿ 03AB	ά 03AC	έ 03AD	ή 03AE	ί 03AF
<b>E0</b>	ύ 03B0	α 03B1	β 03B2	γ 03B3	δ 03B4	ε 03B5	ζ 03B6	η 03B7	θ 03B8	ι 03B9	κ 03BA	λ 03BB	μ 03BC	ν 03BD	ξ 03BE	ο 03BF
<b>F0</b>	π 03C0	ρ 03C1	ς 03C2	σ 03C3	τ 03C4	υ 03C5	φ 03C6	χ 03C7	ψ 03C8	ω 03C9	ι 03CA	υ 03CB	ό 03CC	ύ 03CD	ώ 03CE	™ 2122

### 6.2.17 WPC1255 (80H – FFH)

	00	01	02	03	04	05	06	07	08	09	0A	0B	0C	0D	0E	0F
<b>80</b>	€ 20AC		ƒ 201A	f 0192	„ 201E	… 2026	† 2020	‡ 2C21	ˆ 02C6	‰ 2030		< 2039				
<b>90</b>		˘ 2018	˙ 2019	˚ 201C	˛ 201D	• 2022	– 2013	— 2C14	˜ 02DC	™ 2122		> 203A				
<b>A0</b>	<u>NBSP</u> 00A0	ı 00A1	ç 00A2	£ 00A3	₪ 20AA	¥ 00A5	¦ 00A6	§ 00A7	¨ 00A8	© 00A9	× 00D7	« 00AB	¬ 00AC	– 00AD	® 00AE	— 00AF
<b>B0</b>	° 00B0	± 00B1	² 00B2	³ 00B3	´ 00B4	µ 00B5	¶ 00B6	· 00B7	¸ 00B8	¹ 00B9	÷ 00F7	» 00BB	¼ 00BC	½ 00BD	¾ 00BE	¿ 00BF
<b>C0</b>	˙ 05B0	˚ 05B1	˛ 05B2	˜ 05B3	˘ 05B4	˙ 05B5	˚ 05B6	˛ 05B7	˜ 05B8	˘ 05B9		˙ 05BB	˚ 05BC	˛ 05BD	˜ 05BE	˘ 05BF
<b>D0</b>	 05C0	· 05C1	˙ 05C2	: 05C3	 05F0	 05F1	 05F2	: 05F3	¨ 05F4							
<b>E0</b>	Ɔ 05D0	Ɔ 05D1	Ɔ 05D2	Ɔ 05D3	Ɔ 05D4	Ɔ 05D5	Ɔ 05D6	Ɔ 05D7	Ɔ 05D8	Ɔ 05D9	Ɔ 05DA	Ɔ 05DB	Ɔ 05DC	Ɔ 05DD	Ɔ 05DE	Ɔ 05DF
<b>F0</b>	Ɔ 05E0	Ɔ 05E1	Ɔ 05E2	Ɔ 05E3	Ɔ 05E4	Ɔ 05E5	Ɔ 05E6	Ɔ 05E7	Ɔ 05E8	Ɔ 05E9	Ɔ 05EA			LTR 200E	RTL 200F	





































### 6.2.18 PC775 : Baltic (80H – FFH)

	00	01	02	03	04	05	06	07	08	09	0A	0B	0C	0D	0E	0F
<b>80</b>	Ć 0106	Û 00FC	É 00E9	Ā 0101	Ä 00E4	Ġ 0123	Å 00E5	Ć 0107	Ł 0142	Ē 0113	Ŕ 0156	Ŗ 0157	Ī 012B	Ž 0179	Ä 00C4	Å 00C5
<b>90</b>	É 00C9	æ 00E6	Æ 00C6	ō 014D	ö 00F6	Ģ 0122	č 00A2	š 015A	ś 015B	Ö 00D6	Ü 00DC	ø 00F8	£ 00A3	∅ 00D8	× 00D7	» 00A4
<b>A0</b>	Ā 0100	Ī 012A	ó 00F3	Ž 017B	ž 017C	ž 017A	“ 201D	ı 00A6	© 00A9	® 00AE	¬ 00AC	¼ 00BD	½ 00BC	¾ 0141	« 00AB	» 00BB
<b>B0</b>	■ 2591	■ 2592	■ 2593	 2502	 2524	Ą 0104	Č 010C	Ę 0118	Ė 0116	Į 2563	 2551	Ų 2557	Ų 255D	Ų 012E	Š 0160	Ų 2510
<b>C0</b>	Ł 2514	Ł 2534	Ł 252C	Ł 251C	— 2500	Ł 253C	Ų 0172	Ų 016A	Ł 255A	Ł 2554	Ł 2569	Ł 2566	Ł 2560	Ł 2550	Ł 256C	Ž 017D
<b>D0</b>	ą 0105	č 010D	ę 0119	ė 0117	į 012F	š 0161	ų 0173	ū 016B	ž 017E	Į 2518	Ų 250C	■ 2588	■ 2584	■ 258C	■ 2590	■ 2580
<b>E0</b>	Ó 00D3	ß 00DF	ō 014C	ń 0143	ö 00F5	ō 00D5	µ 00B5	ń 0144	ķ 0136	ķ 0137	Ł 013B	Ł 013C	ŋ 0146	Ē 0112	Ŋ 0145	˘ 2019
<b>F0</b>	— 00AD	± 00B1	“ 201C	¾ 00BE	¶ 00B6	§ 00A7	÷ 00F7	„ 201E	° 00B0	· 2219	· 00B7	¹ 00B9	˚ 00B3	² 00B2	■ 25A0	<u>NBSP</u> 00A0

### 6.2.19 PC864 : Arabic (80H – FFH)

	00	01	02	03	04	05	06	07	08	09	0A	0B	0C	0D	0E	0F
<b>80</b>	° 00B0	· 00B7	• 2219	√ 221A	 2592	— 2500	 2502	+ 253C	⊥ 2524	⊥ 252C	⊥ 251C	⊥ 2534	⊥ 2510	⊥ 250C	⊥ 2514	⊥ 2518
<b>90</b>	β 03B2	∞ 221E	φ 03C6	± 00B1	½ 00BD	¼ 00BC	≈ 2248	« 00AB	» 00BB	لأ FEF7	لأ FEF8			لا FEFB	لا FEFC	س FBFC
<b>A0</b>		- 00AD	آ FE82	£ 00A3	¤ 00A4	أ FE84		€ 20AC	ل FE8E	ب FE8F	ت FE95	ث FE99	، 080C	ج FE9D	ح FEA1	خ FEA5
<b>B0</b>	° 06B0	ا 06B1	ب 06B2	ج 06B3	د 06B4	هـ 06B5	و 06B6	ز 06B7	ح 06B8	ط 06B9	ف FED1	؛ 061B	ع FBF6	ث FBF5	ج FBF4	؟ 061F
<b>C0</b>	ق 00A2	ء FE80	آ FE81	أ FE83	ؤ FE85	ع FECA	ذ FE8B	ا FE8D	ب FE91	ة FE93	ت FE97	ث FE9B	ج FE9F	ح FEA3	خ FEA7	د FEA9
<b>D0</b>	ذ FEAB	ر FEAD	ز FEAF	س FEB3	ش FEB7	ص FEBB	ض FEBF	ط FEC3	ظ FEC7	ع FECB	غ FECF	ا 00A6	ر 00AC	÷ 00F7	× 00D7	ع FEC9
<b>E0</b>	— 0840	ف FED3	ق FED7	ك FED8	ل FEDF	م FEE3	ن FEE7	هـ FEEB	و FEED	ى FEFF	ي FEF3	ض F8F7	ع FECC	ظ FECE	غ FECD	م FEE1
<b>F0</b>	ـ FE7D	ّ FE7C	ن FEE5	هـ FEE9	هـ FEEC	ح FEF0	ي FEF2	غ FED0	ق FED5	لا FEF5	لا FEF6	ل FEDD	ك FED9	ي FEF1		

### 6.2.20 ISO8859-7 (80H – FFH)

	00	01	02	03	04	05	06	07	08	09	0A	0B	0C	0D	0E	0F
<b>80</b>	€ 20AC															
<b>90</b>																
<b>A0</b>	NBSP 00A0	' 02BD	' 02BC	£ 00A3	€ 20AC		 00A6	§ 00A7	¨ 00A8	© 00A9		« 00AB	¬ 00AC	— 00AD		— 2015
<b>B0</b>	° 00B0	± 00B1	² 00B2	³ 00B3	´ 0384	ˆ 0385	À 0386	· 00B7	È 0388	Ì 0389	Î 038A	» 00BB	Ò 038C	¼ 00BD	Ý 038E	Ω 038F
<b>C0</b>	í 0390	À 0391	B 0392	Γ 0393	Δ 0394	E 0395	Z 0396	H 0397	Θ 0398	I 0399	K 039A	Λ 039B	M 039C	N 039D	Ξ 039E	O 039F
<b>D0</b>	Π 03A0	P 03A1		Σ 03A3	T 03A4	Υ 03A5	Φ 03A6	X 03A7	Ψ 03A8	Ω 03A9	Ï 03AA	ÿ 03AB	ά 03AC	έ 03AD	ή 03AE	ί 03AF
<b>E0</b>	ú 03B0	α 03B1	β 03B2	γ 03B3	δ 03B4	ε 03B5	ζ 03B6	η 03B7	θ 03B8	ι 03B9	κ 03BA	λ 03BB	μ 03BC	ν 03BD	ξ 03BE	ο 03BF
<b>F0</b>	π 03C0	ρ 03C1	ς 03C2	σ 03C3	τ 03C4	υ 03C5	φ 03C6	χ 03C7	ψ 03C8	ω 03C9	ϊ 03CA	ÿ 03CB	ό 03CC	ύ 03CD	ώ 03CE	



## 6.2.21 PC857 : Turkish (80H – FFH)

	00	01	02	03	04	05	06	07	08	09	0A	0B	0C	0D	0E	0F
<b>80</b>	Ç 00C7	ü 00FC	é 00E9	ã 00E2	ä 00E4	à 00E0	å 00E5	ç 00E7	ê 00EA	ë 00EB	è 00E8	ï 00EF	î 00EE	ı 0131	Ä 00C4	Å 00C5
<b>90</b>	É 00C9	æ 00E6	Æ 00C6	ö 00F4	ö 00F6	ò 00F2	û 00FB	ù 00F9	İ 0130	Ö 00D6	Û 00DC	ø 00F8	£ 00A3	∅ 00D8	Ş 015E	Ş 015F
<b>A0</b>	á 00E1	í 00ED	ó 00F3	ú 00FA	ñ 00F1	Ñ 00D1	Ĝ 011E	ğ 011F	ı 00BF	® 00AE	¬ 00AC	¼ 00BD	¾ 00BC	ı 00A1	« 00AB	» 00BB
<b>B0</b>	▨ 2591	▩ 2592	▧ 2593	 2502	┆ 2524	Á 00C1	Ã 00C2	À 00C0	© 00A9	¶ 2563	 2551	⌋ 2557	⌌ 255D	¢ 00A2	¥ 00A5	⌋ 2510
<b>C0</b>	L 2514	┆ 2534	T 252C	┆ 251C	— 2500	† 253C	ã 00E3	Ã 00C3	ℒ 255A	℞ 2554	⌌ 2569	⌋ 2566	⌌ 2560	= 2550	⌌ 256C	※ 00A4
<b>D0</b>	° 00BA	ª 00AA	Ê 00CA	Ë 00CB	È 00C8	€ 20AC	Í 00CD	Î 00CE	Ï 00CF	┆ 2518	┆ 250C	■ 2588	■ 2584	ı 00A6	ì 00CC	■ 2580
<b>E0</b>	Ó 00D3	ß 00DF	Õ 00D4	Ò 00D2	ö 00F5	Õ 00D5	µ 00B5	▨ 2591	× 00D7	Ú 00DA	Û 00DB	Û 00D9	ì 00EC	ÿ 00FF	— 00AF	´ 00B4
<b>F0</b>	— 00AD	± 00B1	▨ 2591	¾ 00BE	¶ 00B6	§ 00A7	÷ 00F7	· 00B8	° 00B0	· 00A8	· 00B7	ı 00B9	ε 00B3	z 00B2	■ 25A0	<u>NBSP</u> 00A0

## 7. Display Module Dimension

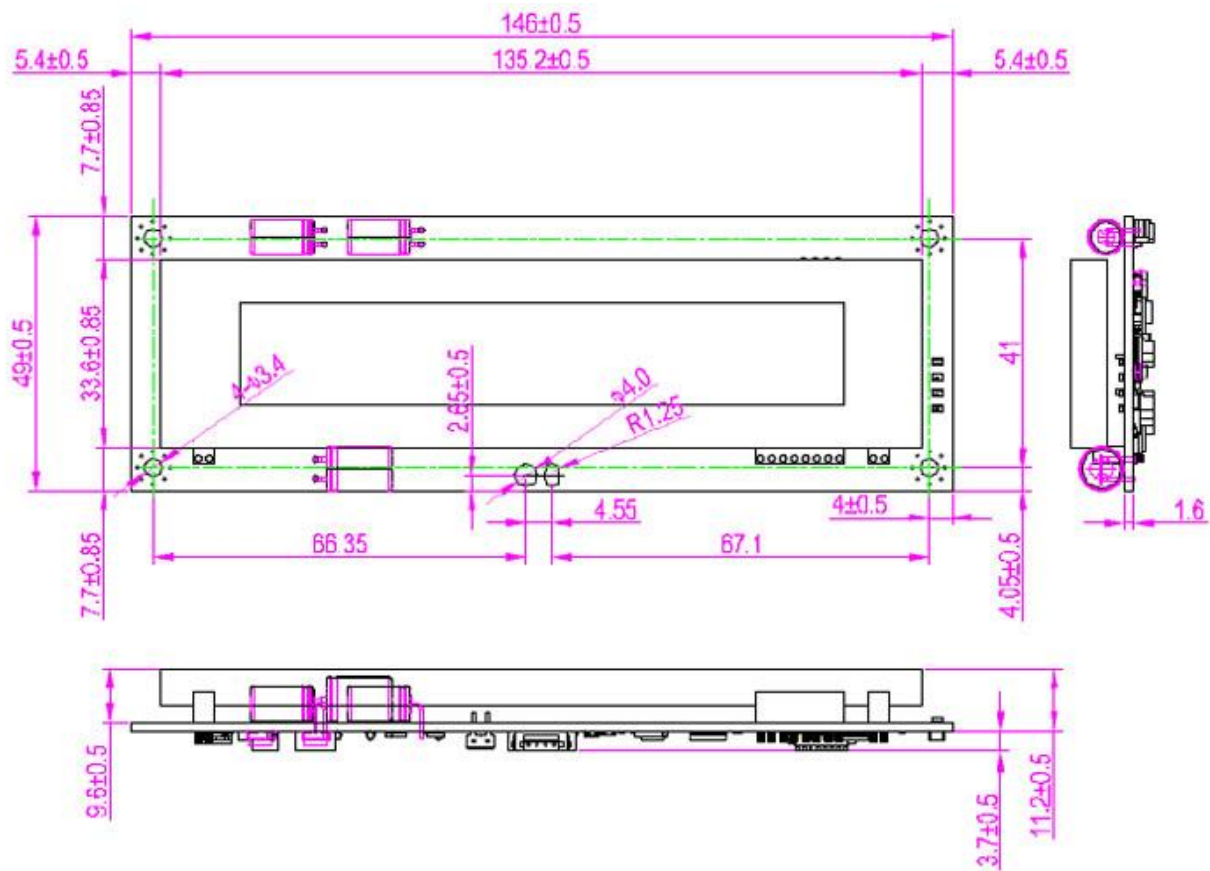

# 8. Tube Dimension (in mm)

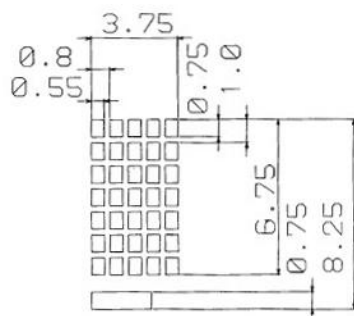
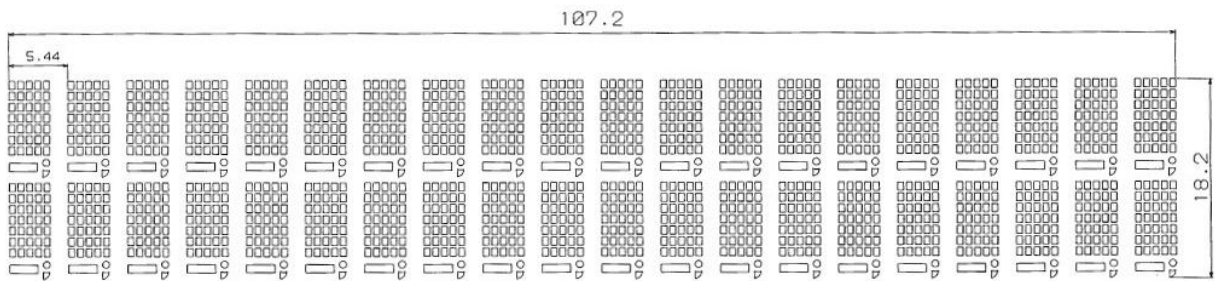
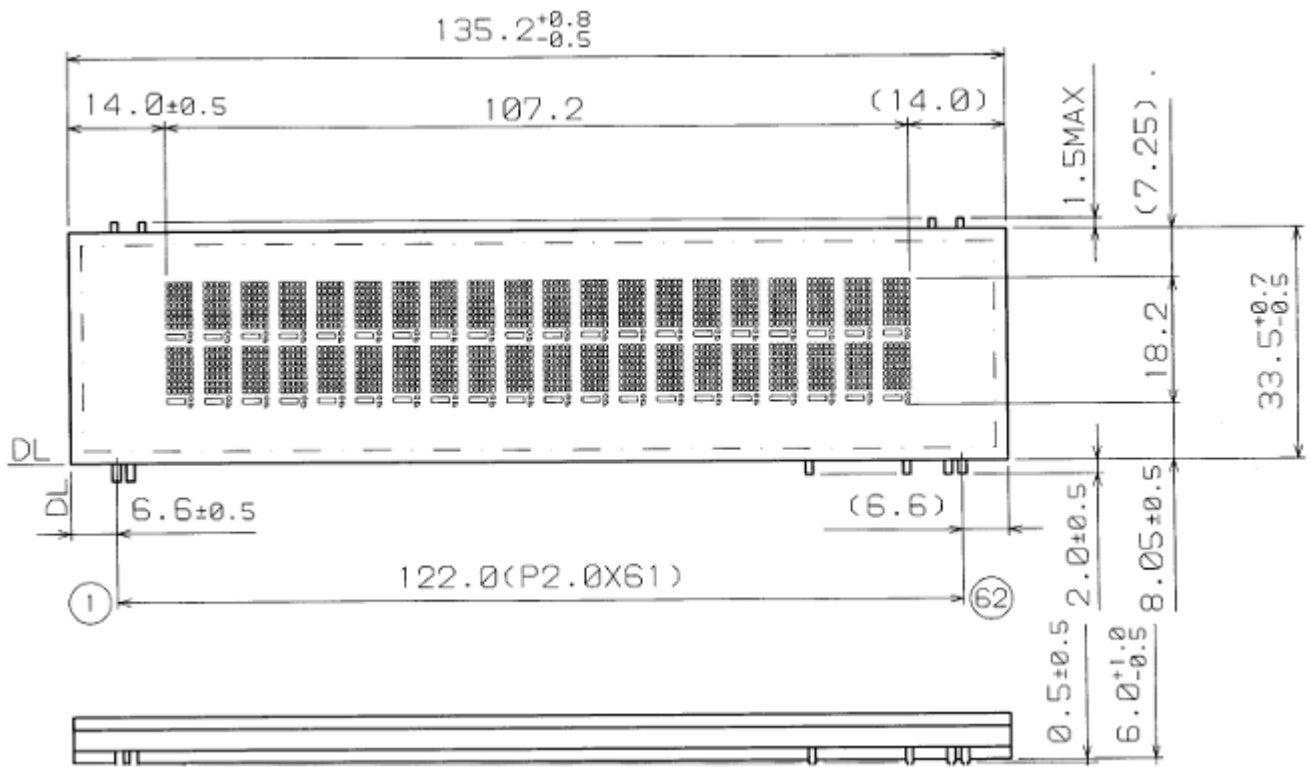

## 9. Default Setting Commands

### 9.1 Baud rate setting command

Code (hex)	Function description
[02h][05h][42h] n [03h]	Change the baud rate setting

n (hex)	Baud rate
30h	4800
31h	9600
32h	19200
33h	38400
39h	115200

### 9.2 Parity check setting command

Code (hex)	Function description
[02h][05h][50h] n [03h]	Change the format setting

n (hex)	Format
30h	N, 8, 1
31h	E, 8, 1
32h	O, 8, 1

### 9.3 Data Length setting command

Code (hex)	Function description
[02h][05h][4Ch] n [03h]	Change the data length setting

n (hex)	Format
37h	7 bits
38h	8 bits

## 9.4 Select international character set command

Code (hex)	Function description
[02h][05h][53h] n [03h]	Change international character set

n (hex)	Character set (20h – 7Fh)	Code table (80h - FFh)
30h	U.S.A.	PC437 (USA, Standard Europe)
31h	France	PC858 (Multilingual + Euro Symbol)
32h	Germany	
33h	U.K.	
34h	Denmark I	
35h	Sweden	
36h	Italy	
37h	Spain	
38h	Japan	
39h	Norway	PC858
3Ah	Denmark II	
3Bh	Salween	
3Ch	Russian	
3Dh	U.S.A.	PC860 (Portuguese)
3Eh	U.K.	Greek
3Fh	U.S.A.	PC852 (Hungary)
40h	U.S.A.	PC862 (Hebrew)
41h	U.S.A.	PC863 (Canadian-France)
42h	U.S.A.	PC865 (Nordic)
43h	U.S.A.	PC866 (Cyrillic)
44h	U.S.A.	WPC1251 (Cyrillic)
45h	U.S.A.	WPC1252 (West European Latin)
46h	U.S.A.	WPC1255 (Hebrew)
47h	U.S.A.	WPC1257 (Baltic)
48h	U.S.A.	WPC1253 (Greek)
49h	U.S.A.	WPC1250 (East European Latin)

## 9.5 Select international character command

<b>Code (hex)</b>	<b>Function description</b>
[02h][05h][54h] n [03h]	Change international character set

<b>n (hex)</b>	<b>International character set</b>
00h	U.S.A.
01h	France
02h	Germany
03h	U.K.
04h	Denmark I
05h	Sweden
06h	Italy
07h	Spain
08h	Japan
09h	Norway
0Ah	Denmark II

## 9.6 Select code table command

Code (hex)	Function description
[02h][05h][55h] n [03h]	Change code page table

n (hex)	Character code table
00h	PC437 (USA, Standard Europe)
01h	Katakana (for Japan)
02h	PC850 (Multilingual)
03h	PC860 (Portuguese)
04h	PC863 (Canadian-French)
05h	PC865 (Nordic)
06h	Salween
07h	Russia
08h	Greek
09h	PC852 (Hungary)
0Ah	PC862 (Hebrew)
0Bh	PC866 (Cyrillic)
0Ch	WPC1251 (Cyrillic)
0Eh	WPC1255 (Hebrew)
0Fh	WPC1257 (Baltic)
10h	WPC1252 (West European Latin)
11h	WPC1253 (Greek)
12h	WPC1250 (East European Latin)
13h	PC858 (Multilingual + Euro Symbol)

## 9.7 Command type setting command

Code (hex)	Function description
[02h][05h][43h] n [03h]	Change command type

n (hex)	Command
30h	DSP800
31h	ESC/POS
32h	POS7300
33h	ADM787
34h	AEDEX
35h	UTC/P
36h	UTC/S
37h	CD5220

## 9.8 Show firmware version

Code (hex)	Function description
[02h][05h][56h][01h][03h]	Show firmware version

## 9.9 Save current screen data as title data

Code (hex)	Function description
[02h][05h][08h][31h][03h]	Save current screen data as title data



## 9.10 Clear setup data

Code (hex)	Function description
[02h][05h][07h] n [03h]	Clear setup data in flash memory

n (hex)	Command
30h	Clear all setup data
31h	Clear others setup data exceed setup title data
32h	Clear setup title data only

## 9.11 Display restart

Code (hex)	Function description
[02h][05h][40h][30h][03h]	Display restart